

BRIDGEWATER MARRIOTT

LOBBY & GROUND FLOOR AMENITIES SCHEMATIC DESIGN- NOVEMBER 1ST, 2017

AUTOGRAPH
COLLECTION®
HOTELS

PEARLE
HOSPITALITY

STUDIO
MUNGE

WE DO MORE THAN INTERIOR DESIGN.

We think beyond walls and floors and imagine the shared experience.

WE CREATE MORE THAN PRETTY PICTURES.

Studio Munge creates the energy that audiences respond to and brings businesses to life.

Since 1997, we have been positively impacting the communities and cities we design in.

WE IMAGINE EXCITING SPACES.

Spaces that people want to be a part of. We have a keen insight, foresight, and passion for the flow of design that brings a space to life.

LOCAL CONTEXT SITE MAP

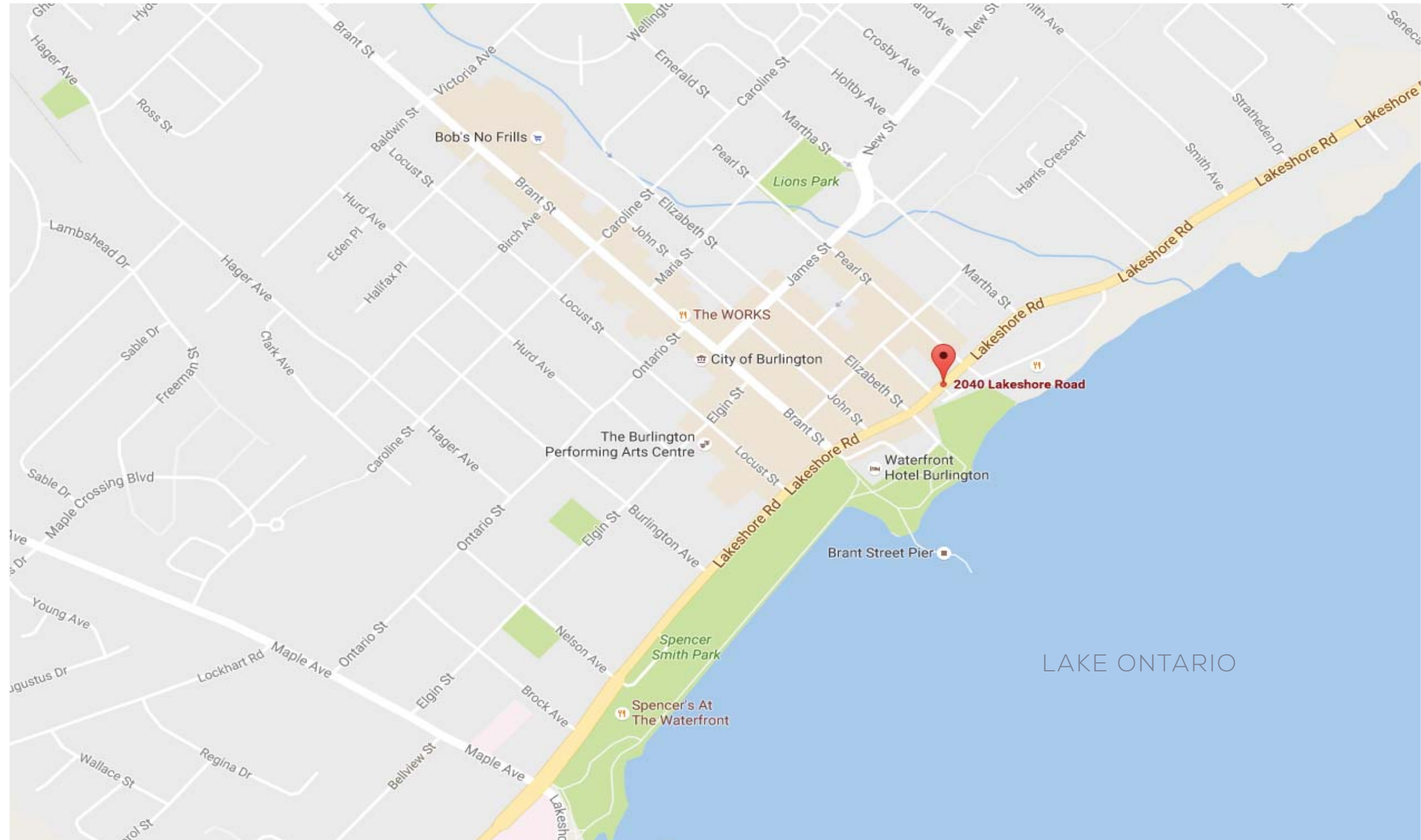

LOCAL CONTEXT LIFE AROUND THE LAKE

BRANT PIER



SPENCER SMITH PARK

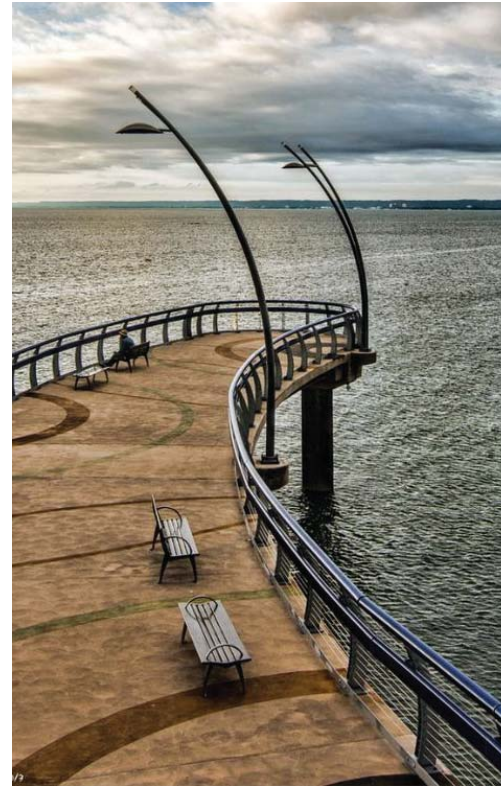

HIKING TRAIL



FARMER'S MARKET



SOCIAL

TARGET CONSUMER MINDSETS, OUR GUESTS

MEET OUR GUESTS

CULTURED VACATIONER

SPECIAL DAY



MODERN BUSINESS

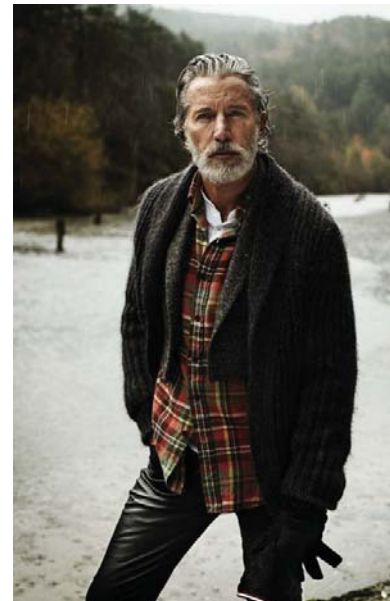

WEEKEND



FAMILY

MODERN COTTAGE



PLACE OF RETREAT



MODERN LAKE HOUSE

The family spent their first day in this remote lake house, set in a tangle of trees formed with astonishment, grassed with familiarity, flowering with impressions, and begging for touch and discovery, and what sounds could be drawn were faint, forgotten melodies echoing down the hallways and through the chambers, Looking out the windows as the season changes....

Michelle Dane



CONNECTED TO NATURE

MEMORIES ARE CREATED



A JOURNEY EMBRACING EACH SEASON

WINTER WARMTH

SPRING AWAKENING

SUMMER VITALITY

AUTUMN COLOURS

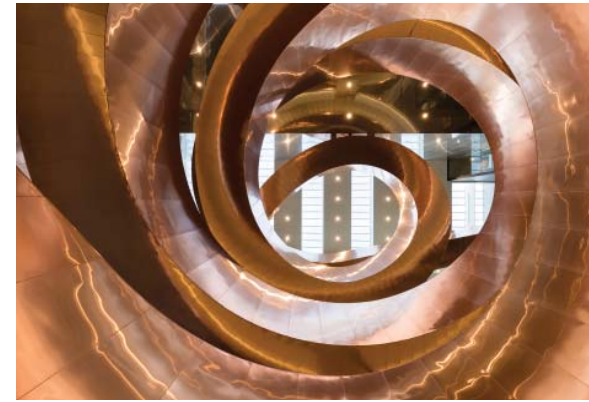

BRIDGEWATER HOTEL

Burlington is a city that embraces the unique character of its relax lake living. Bridgewater Hotel, located where the lake meets the shores. The surrounding, Spencer park and the Brant Pier, frame a perfect gateway offering its guests a truly distinct, personal and local experience in every season.

OVERALL FEEL: TIMELESS

Filled with daylight and views to outdoors, we see bridgewater hotel as an unexpected retreat within the city. A property marrying an appreciation for the great outdoors nestled within contemporary setting set in growing cosmopolitan city.

HONEST

NATURAL

ELEGANT

TIMELESS

WARM

FRESH

CONTEMPORARY

THE GUEST WALKTHROUGH:

Exploring the guests' journey through the lens of interior design across all touchpoints:

- 01 LOWER LOBBY
- 02 ELEVATOR CAB
- 03 ELEVATOR LOBBY
- 04 UPPER LOBBY
- 05 SPA
- 06 TREATMENT ROOM
- 07 FITNESS
- 08 SWIMMING POOL



AUTUMN:

Autumn Song

Autumn, our poor garden is all falling down,
the yellowed leaves are flying in the wind.

-October, TCHAIKOVSKY

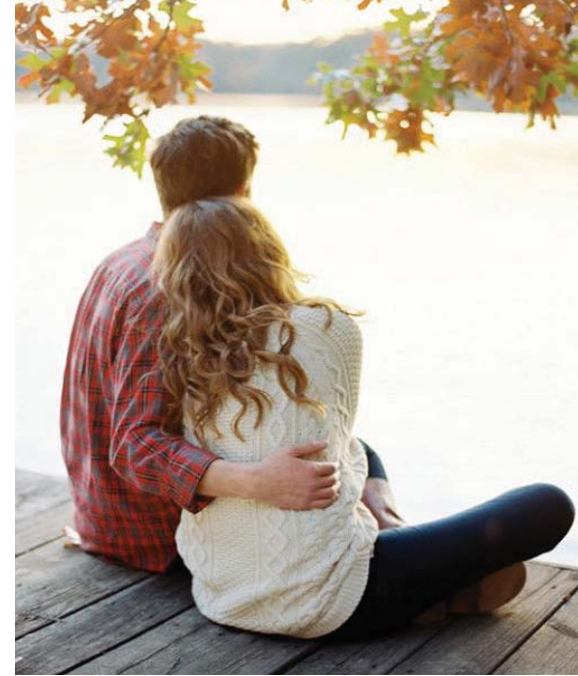

PORTE COCHERE SENSE OF ARRIVAL

SENSE OF ARRIVAL



EXPERIENCE



REVEAL



TEXTURE

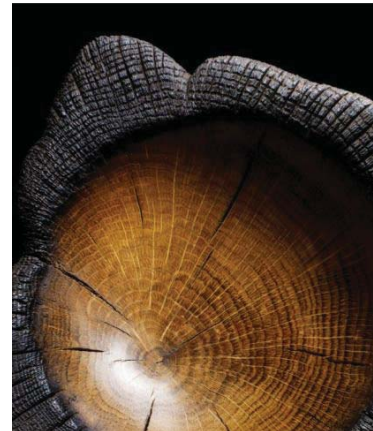

WARMTH



TRANSPARENCY



NATURE



"THE ESSENCE OF THE BEAUTIFUL IS UNITY IN VARIETY"

- FELIX MENDELSSOHN

LOWER GROUND FLOOR LOBBY CONCEPT IMAGES

CURIOSITY



TEXTURES CONNECTING TO NATURE



ACCENTS



WARMTH



NATURAL CHANGES IN HONEST MATERIALS

GROUND FLOOR ELEVATOR LOBBY CONCEPT IMAGES



COMFORT

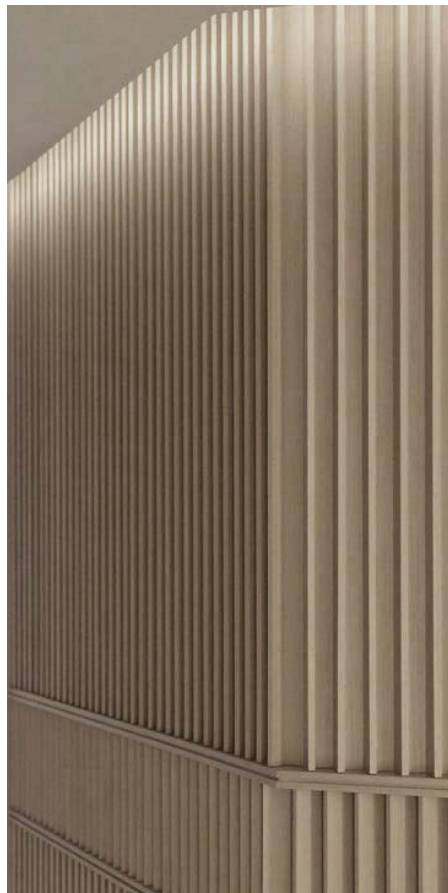
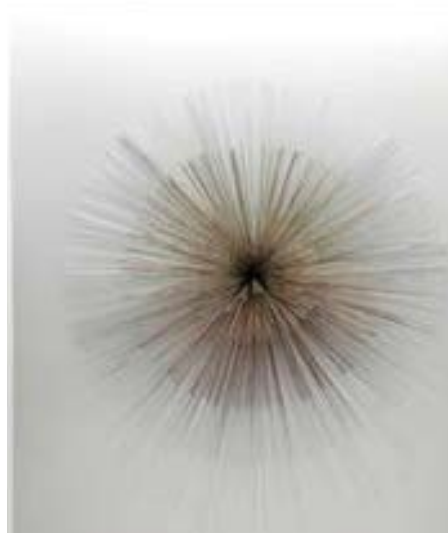

WARMTH



LOWER GROUND FLOOR LOBBY MATERIAL AND FINISHES



- 1 WALL AND ELEVATOR CAB WALL
- 2 STAIRS RAILING AND UNDER
- 3 RECEPTION DESK
- 4 GENERAL METAL
- 5 MIRROR IN ELEVATOR CAB
- 6 FLOOR
- 7 FIREPLACE
- 8 RUG
- 9 FF&E FABRIC

PUBLIC AREA LOWER GROUND FLOOR LOBBY

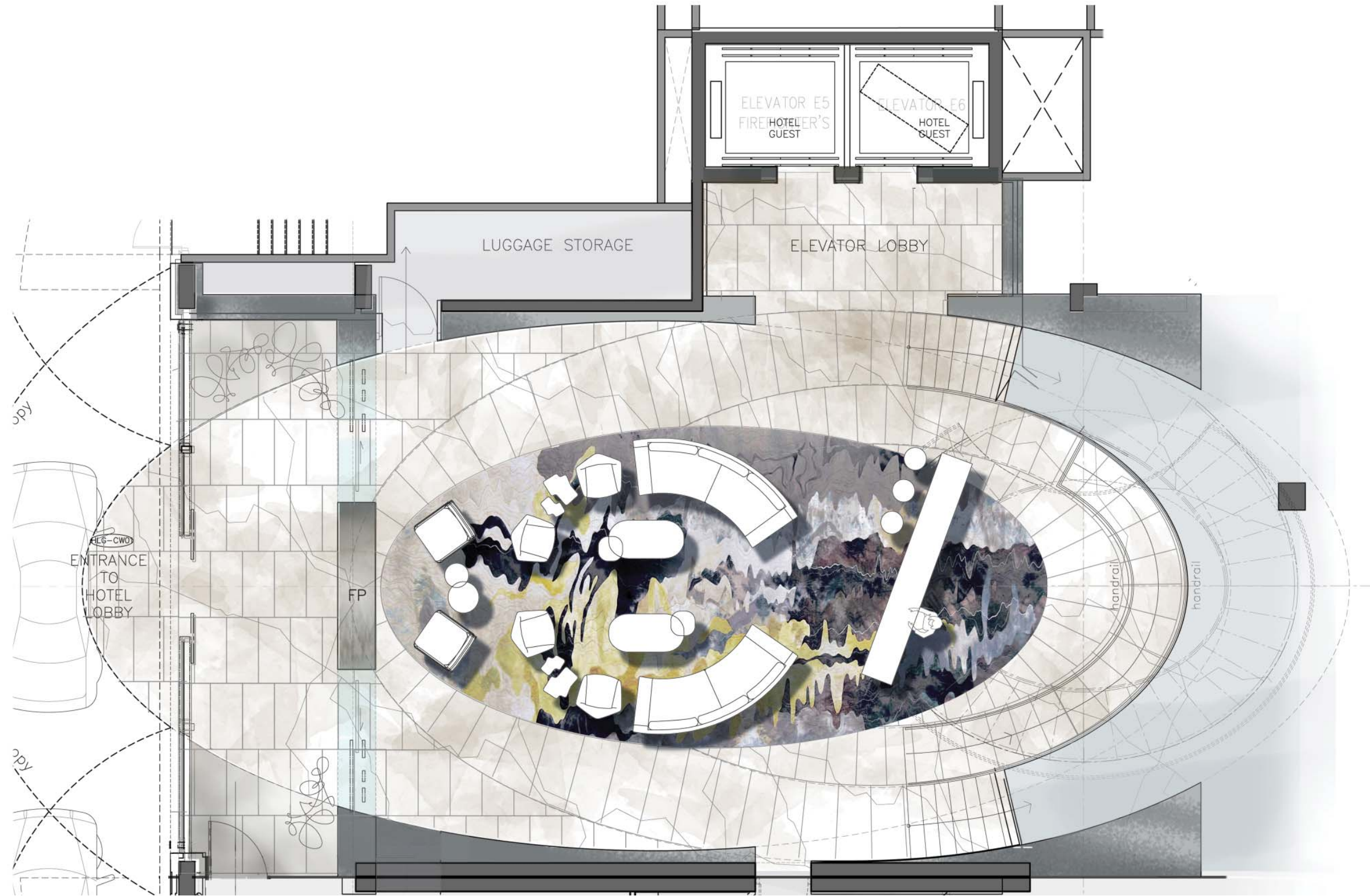

PUBLIC AREA LOWER GROUND WALL FINISHES PLAN

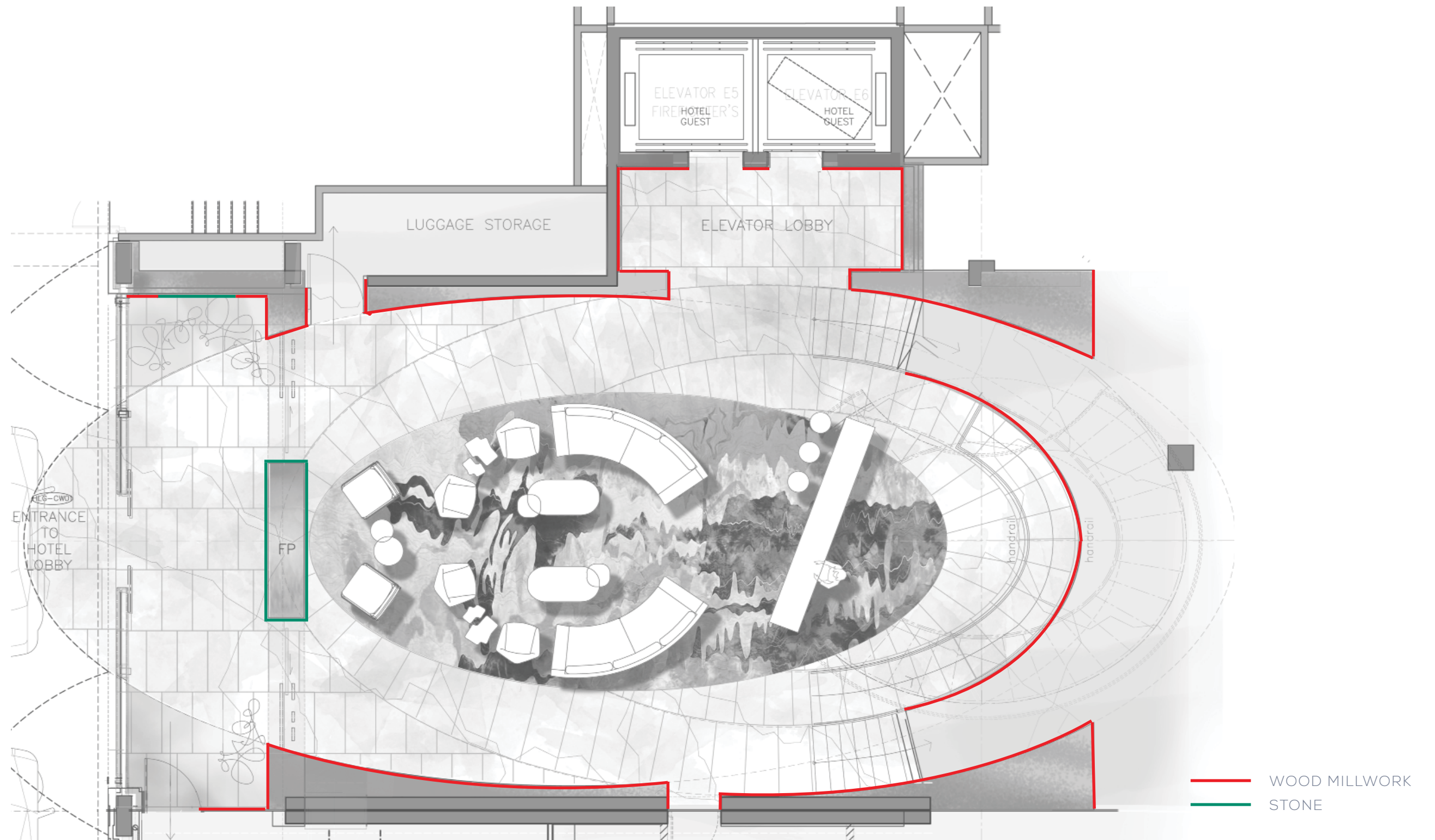

LOWER GROUND FLOOR LOBBY FURNITURE



SOFA



COFFEE TABLE CONCEPT



BARSTOOL



NESTING SIDE TABLES



LOUNGE CHAIR



SIDE TABLES



LOUNGE CHAIR

PUBLIC AREA LOWER GROUND FLOOR LOBBY ELEVATIONS

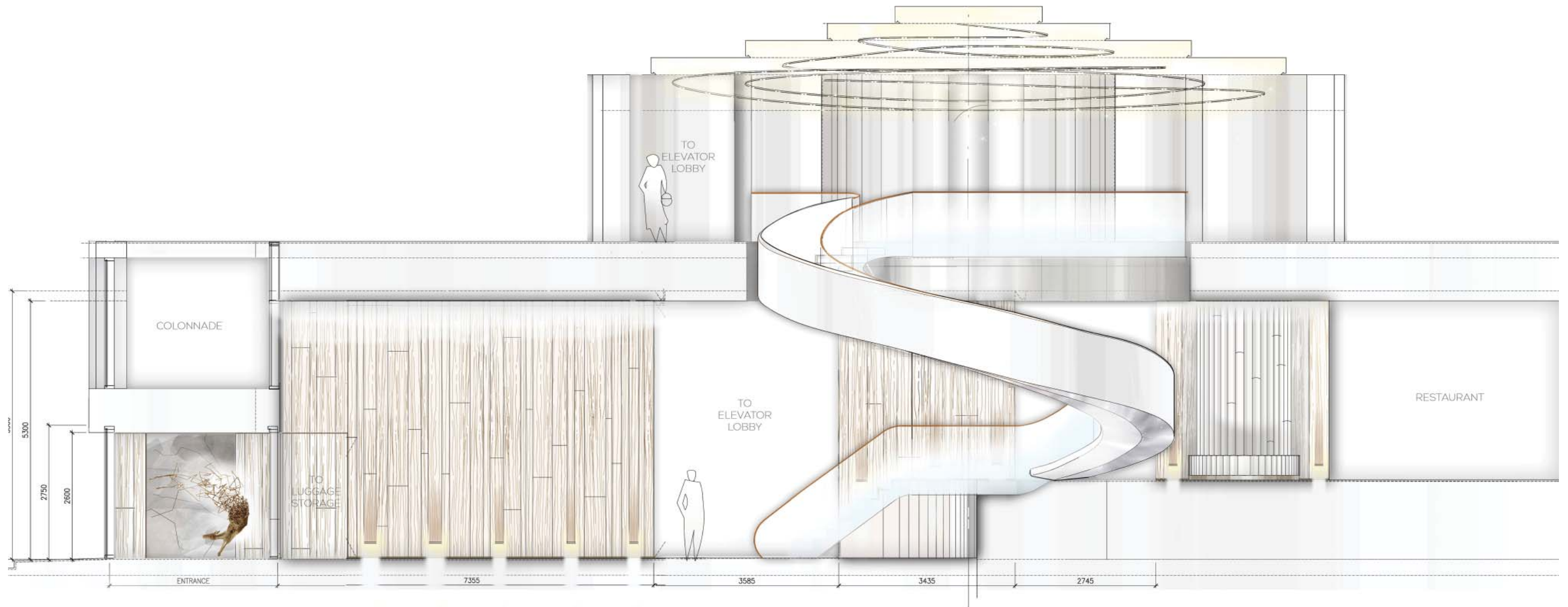
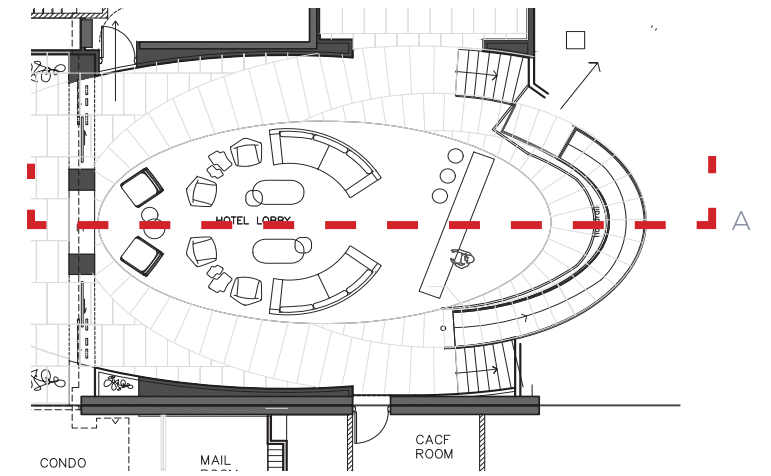

ELEVATION:A

PUBLIC AREA LOWER GROUND FLOOR LOBBY ELEVATIONS



PLAN

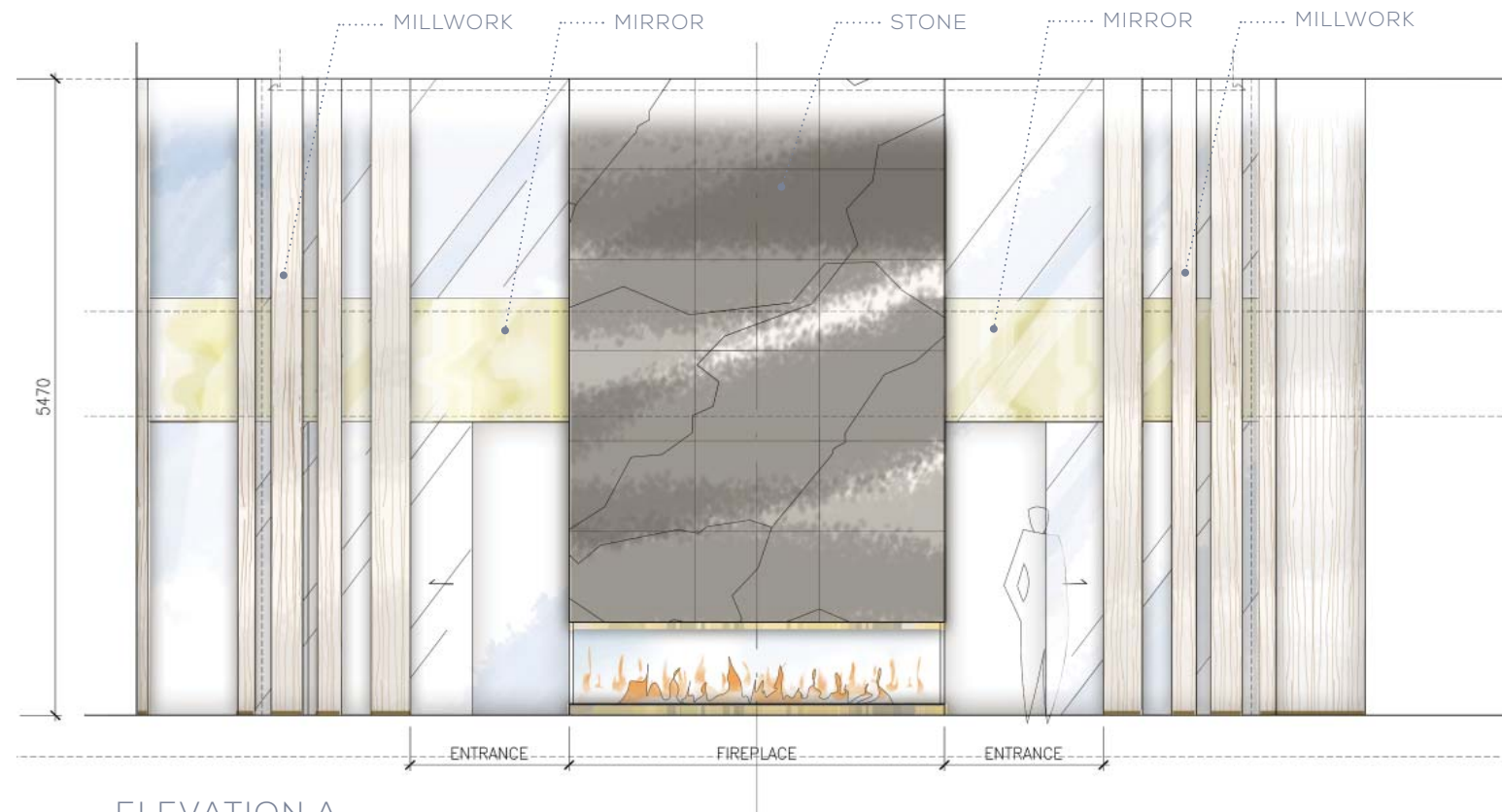
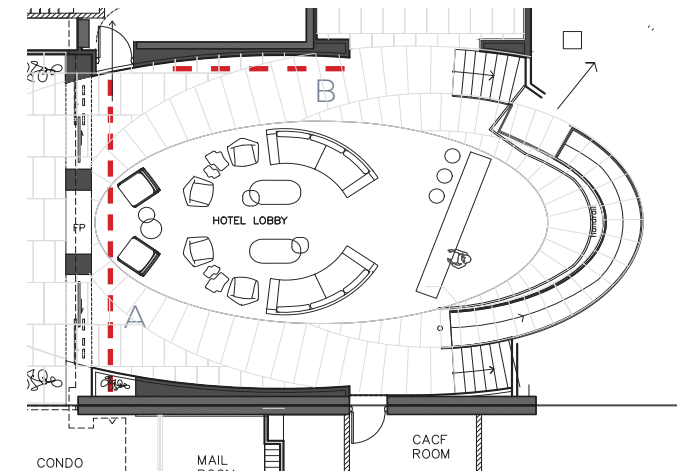

ELEVATION:A



ELEVATION:B

PUBLIC AREA LOWER GROUND FLOOR LOBBY PERSPECTIVE

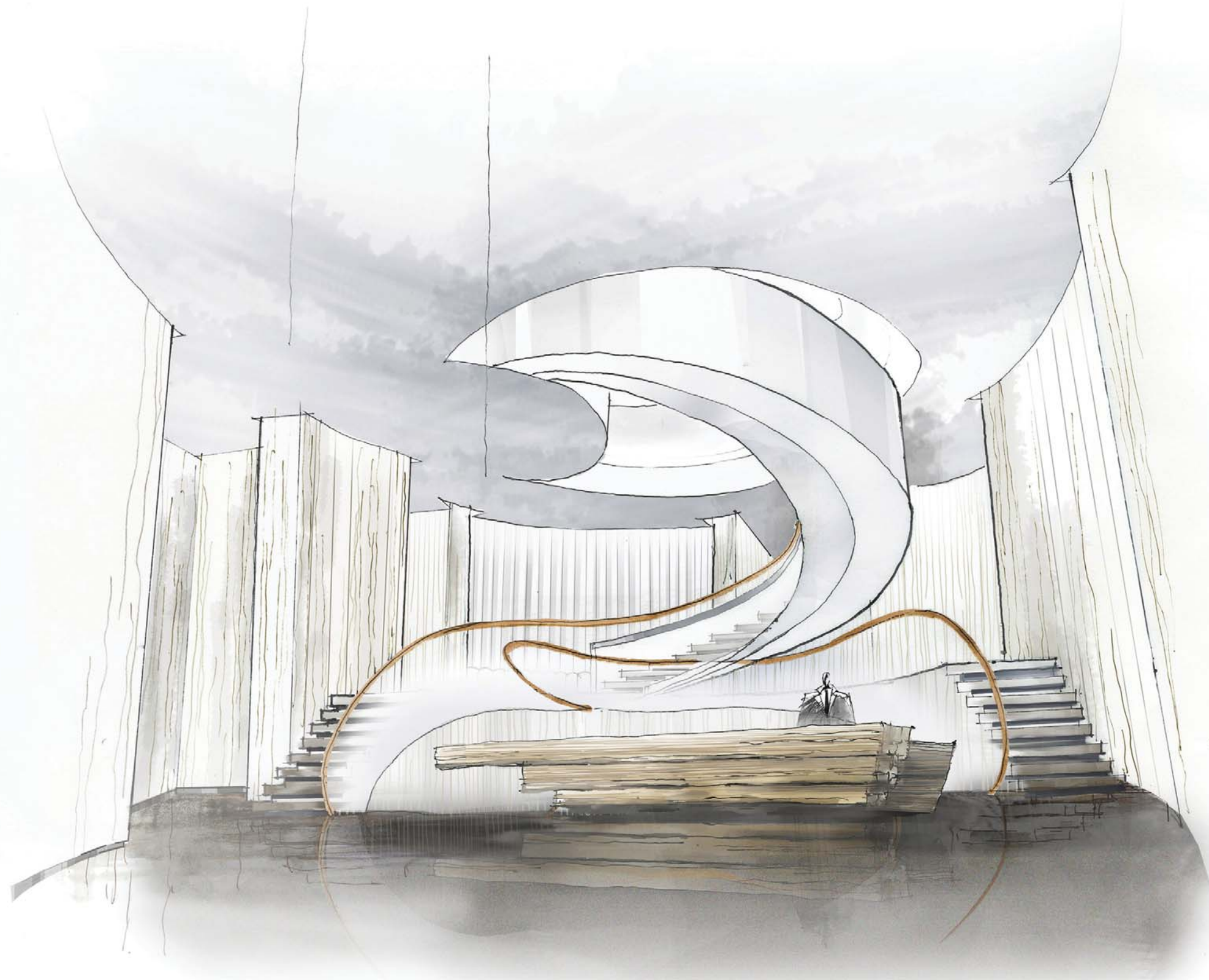

PUBLIC AREA LOWER GROUND FLOOR LOBBY PERSPECTIVE

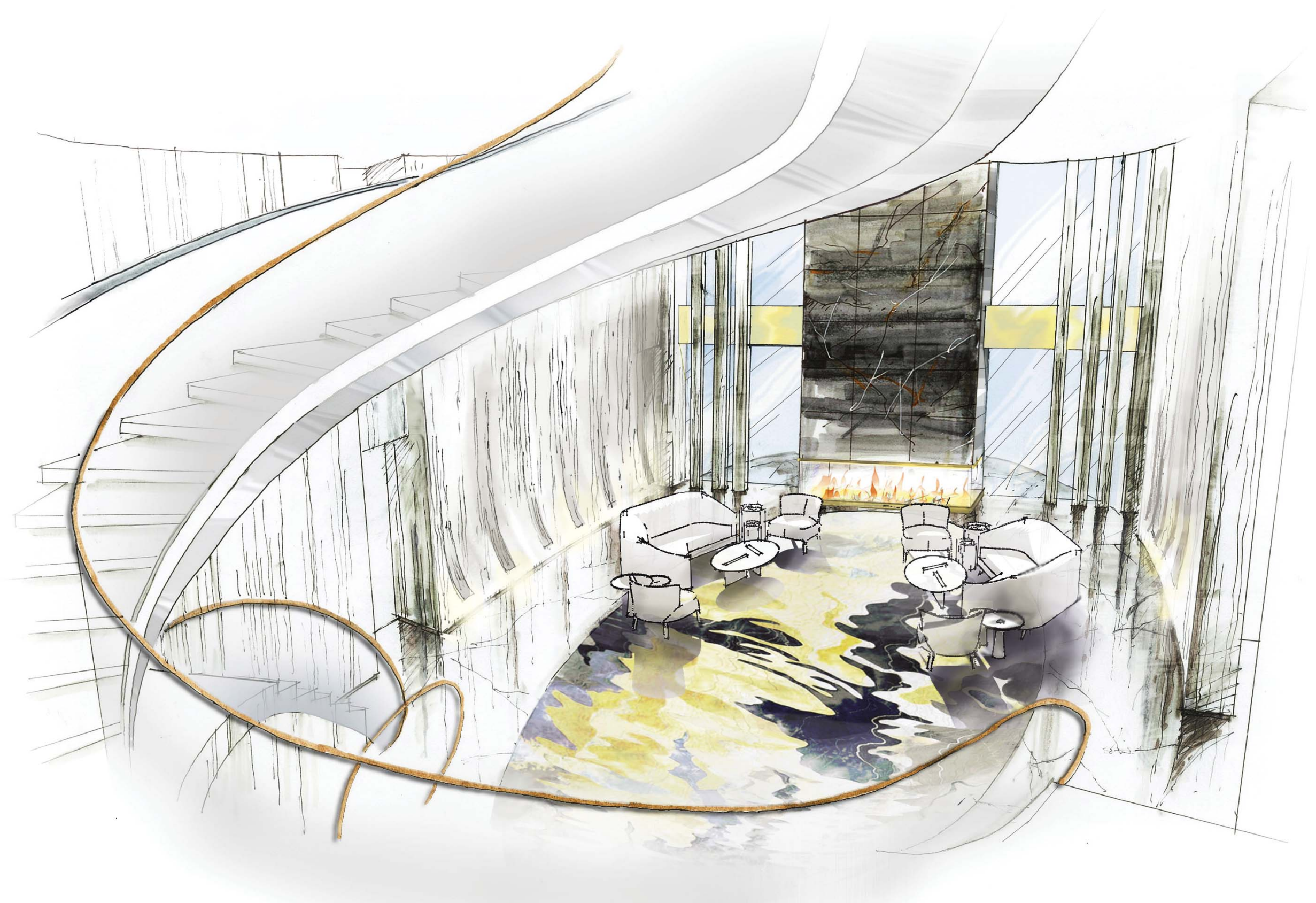

PUBLIC AREA LOWER GROUND FLOOR LOBBY PERSPECTIVE

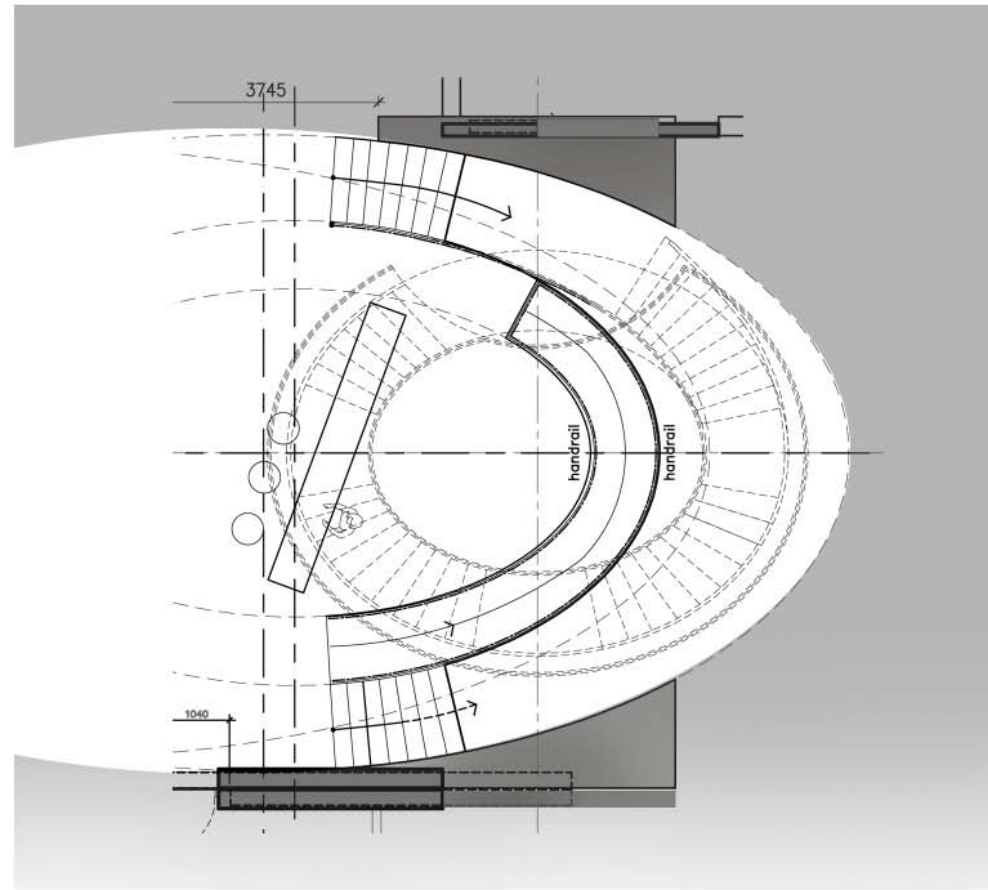

LOWER TO GROUND FLOOR

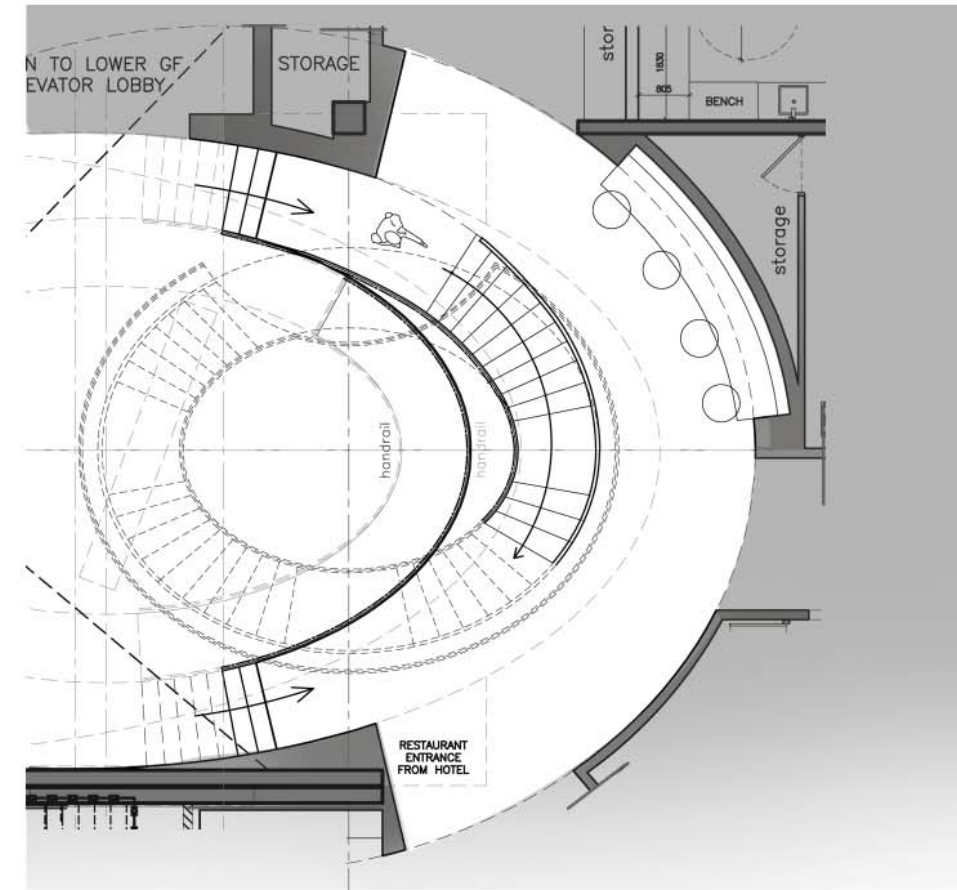

GROUND FLOOR TO 2ND FLOOR

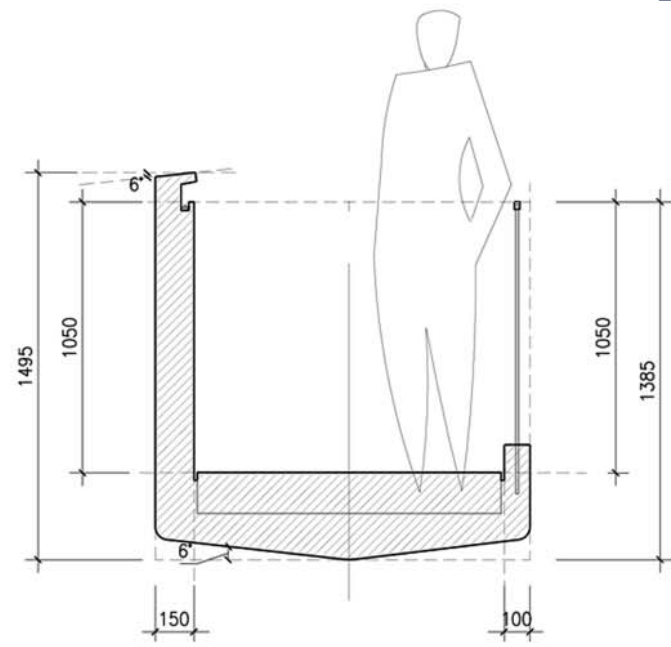

RAILING PROFILE OPTION 1

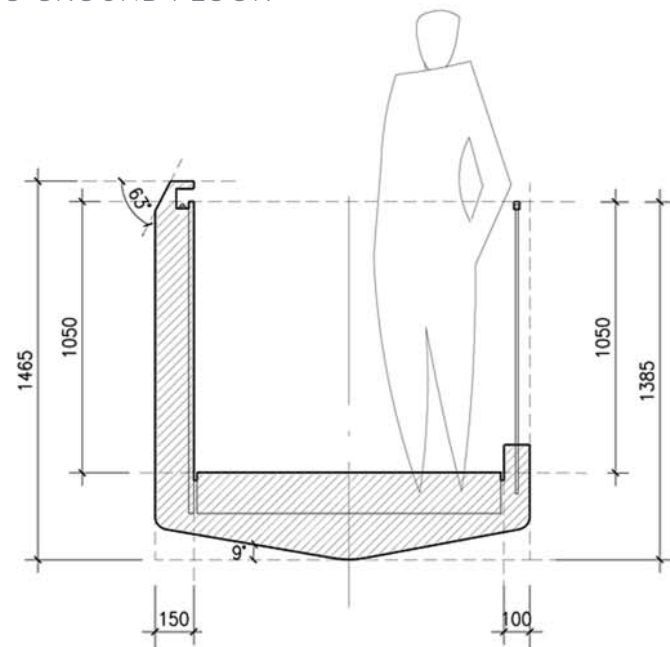

RAILING PROFILE OPTION 2

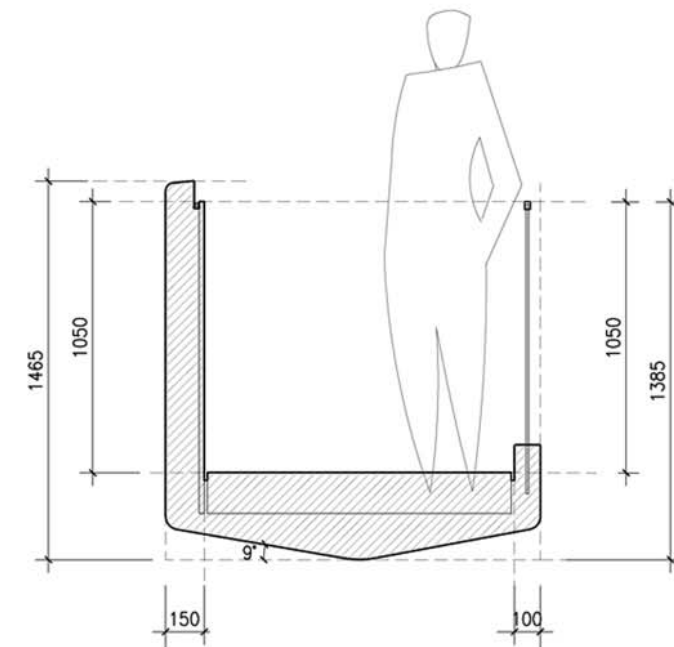

RAILING PROFILE OPTION 3

PUBLIC AREA LOWER GROUND FLOOR LOBBY PERSPECTIVE

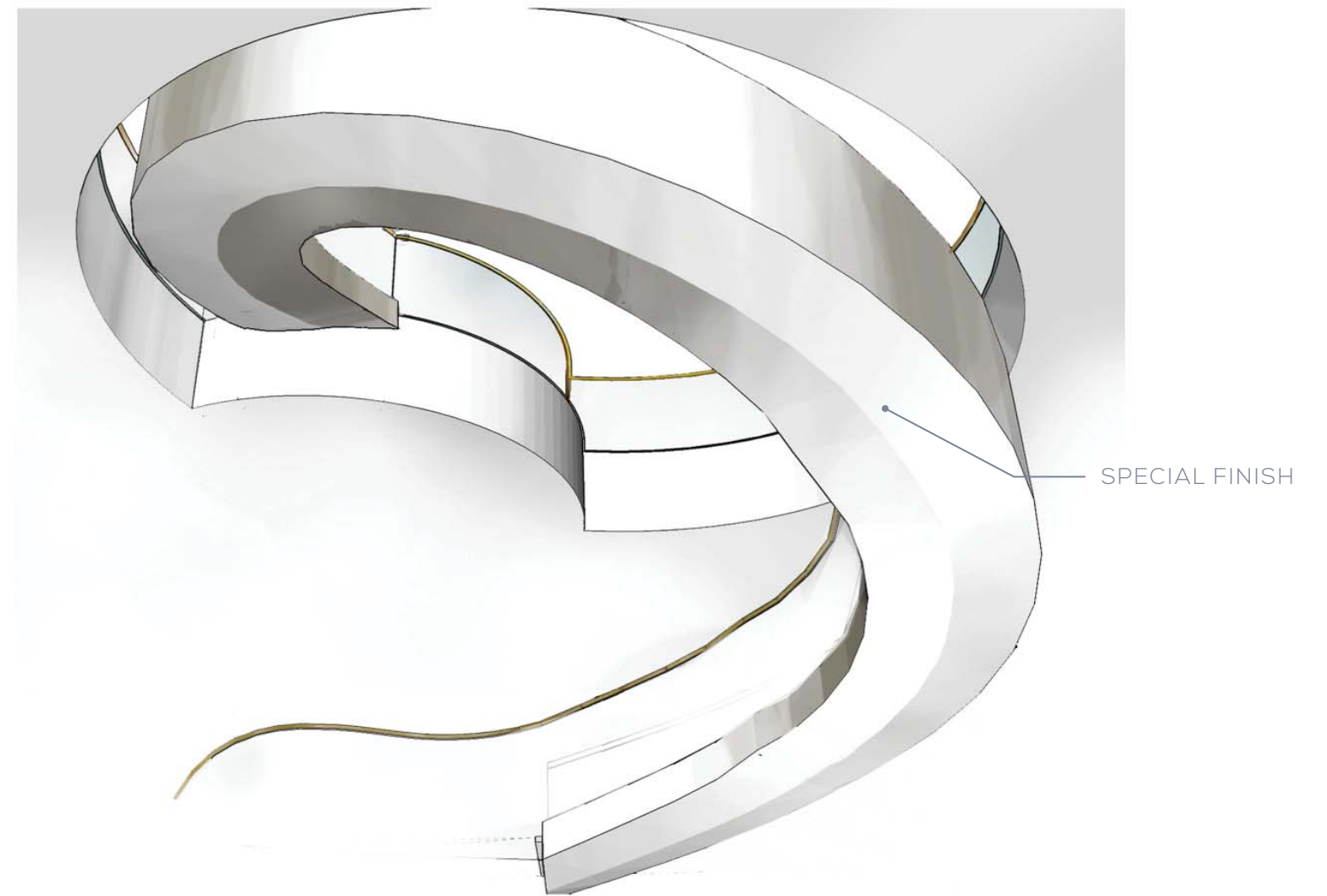
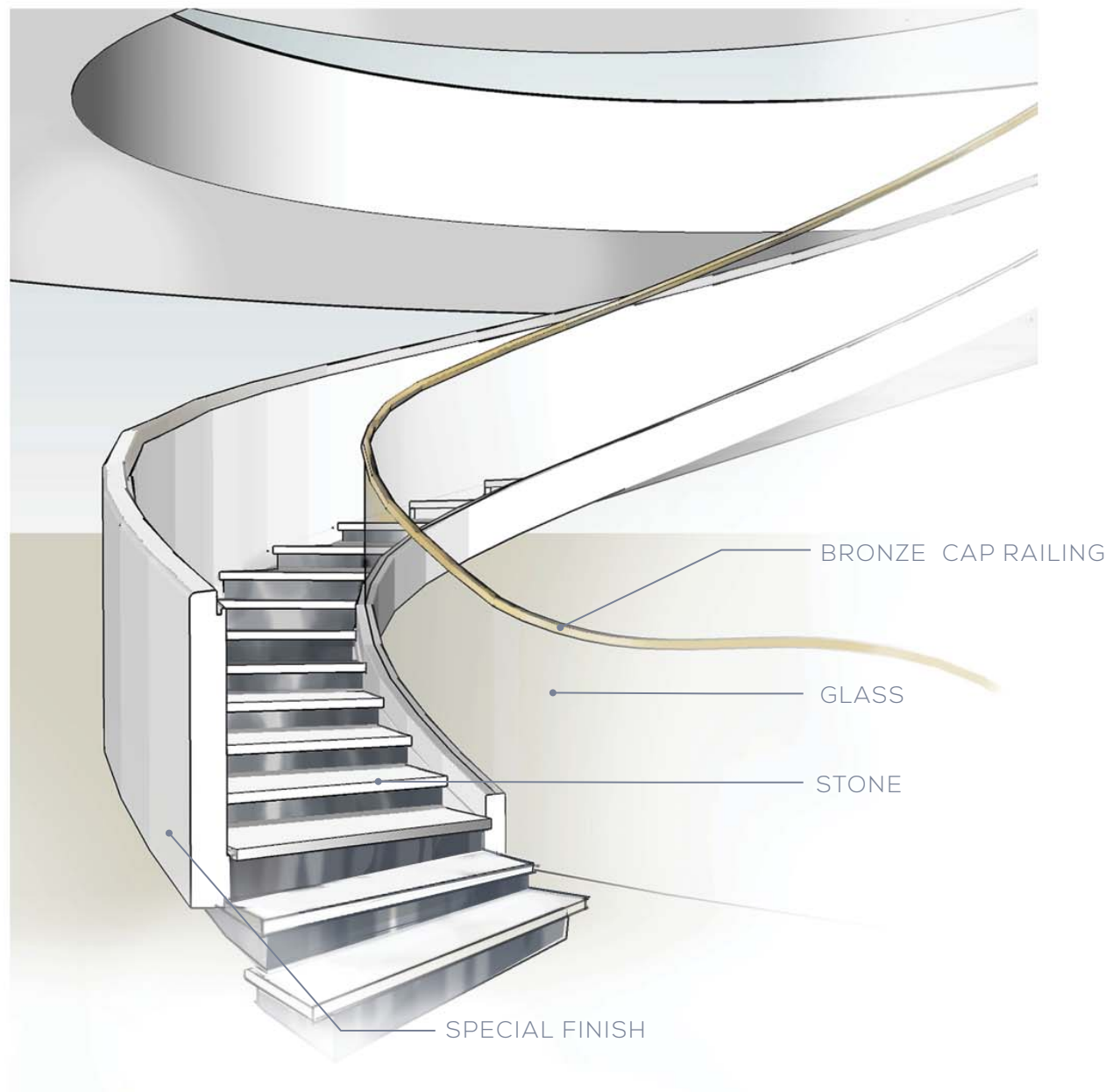

PUBLIC AREA ELEVATOR CAB

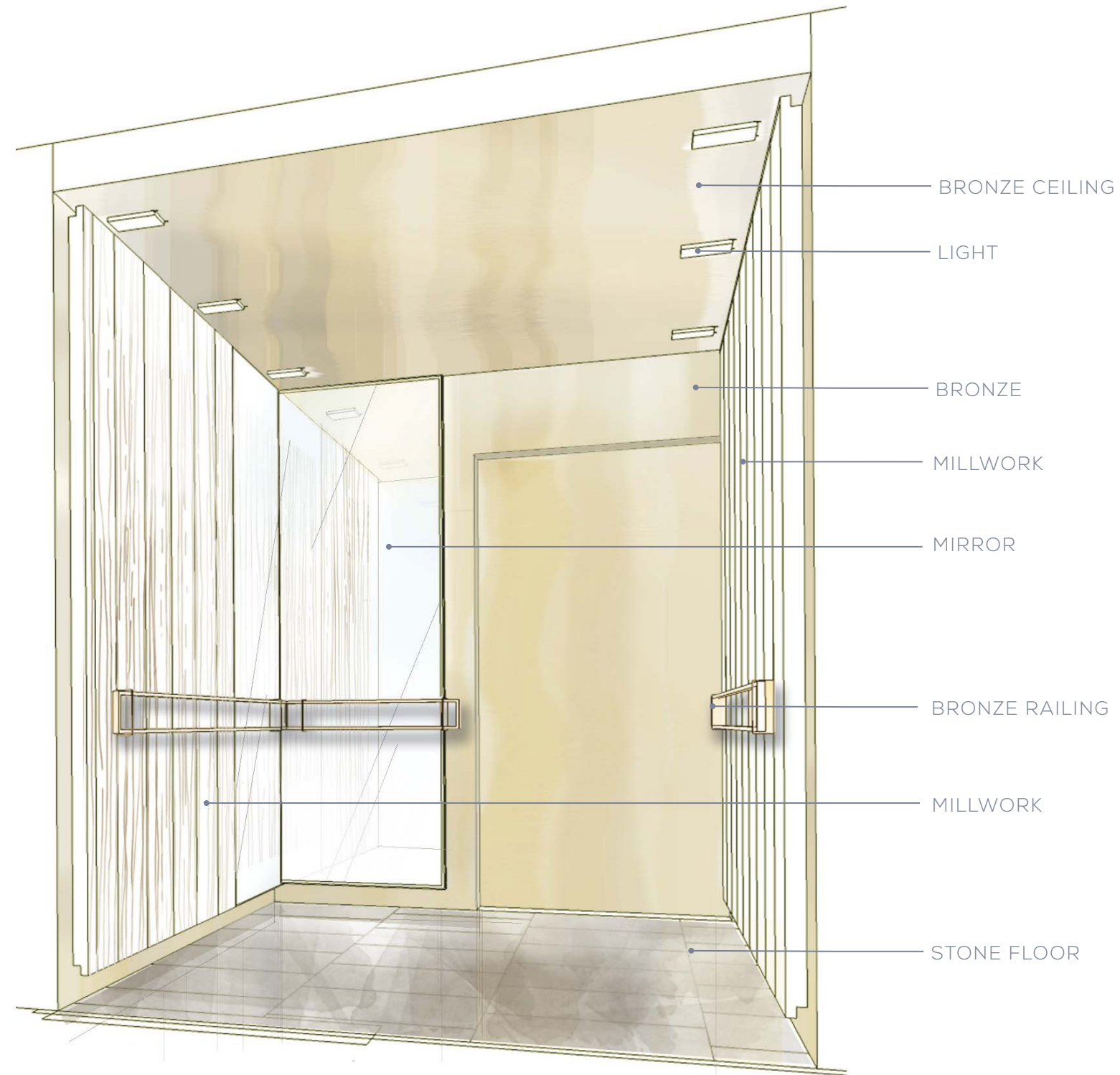

SPRING:

Last Snowdrop

The stars swirling in the heavens,
The blue, pure snowdrop – flower,
and near it the last snowdrops.

The last tears over past griefs,
and first dreams of another happiness

-APRIL, TCHAIKOVSKY



GROUND FLOOR SPA RECEPTION AND RETAIL CONCEPT IMAGES

FRESHNESS



NATURAL



CURIOSITY



STORY TELLING



SOFT & FEMININE

STRONG ARCHITECTURAL

GROUND FLOOR FITNESS AND SPA CONCEPT IMAGES

DETAILS



RELAX



REVEAL



SURPRISE



COMFORT



ART



CONNECT TO NATURE

LOWER GROUND FLOOR SPA FURNITURE



SOFT AND COMFORTABLE SEATING



NESTING COFFEE TABLES



SOFA



LOUNGE CHAIR



LOUNGE CHAIR



SIDE TABLE

LOWER GROUND FLOOR SPA FURNITURE



CABANA DAY BED



SIDE TABLE



LOUNGE CHAIR



POOL DAY BED



SIDE TABLE

PUBLIC AREA UPPER GROUND FLOOR LOBBY

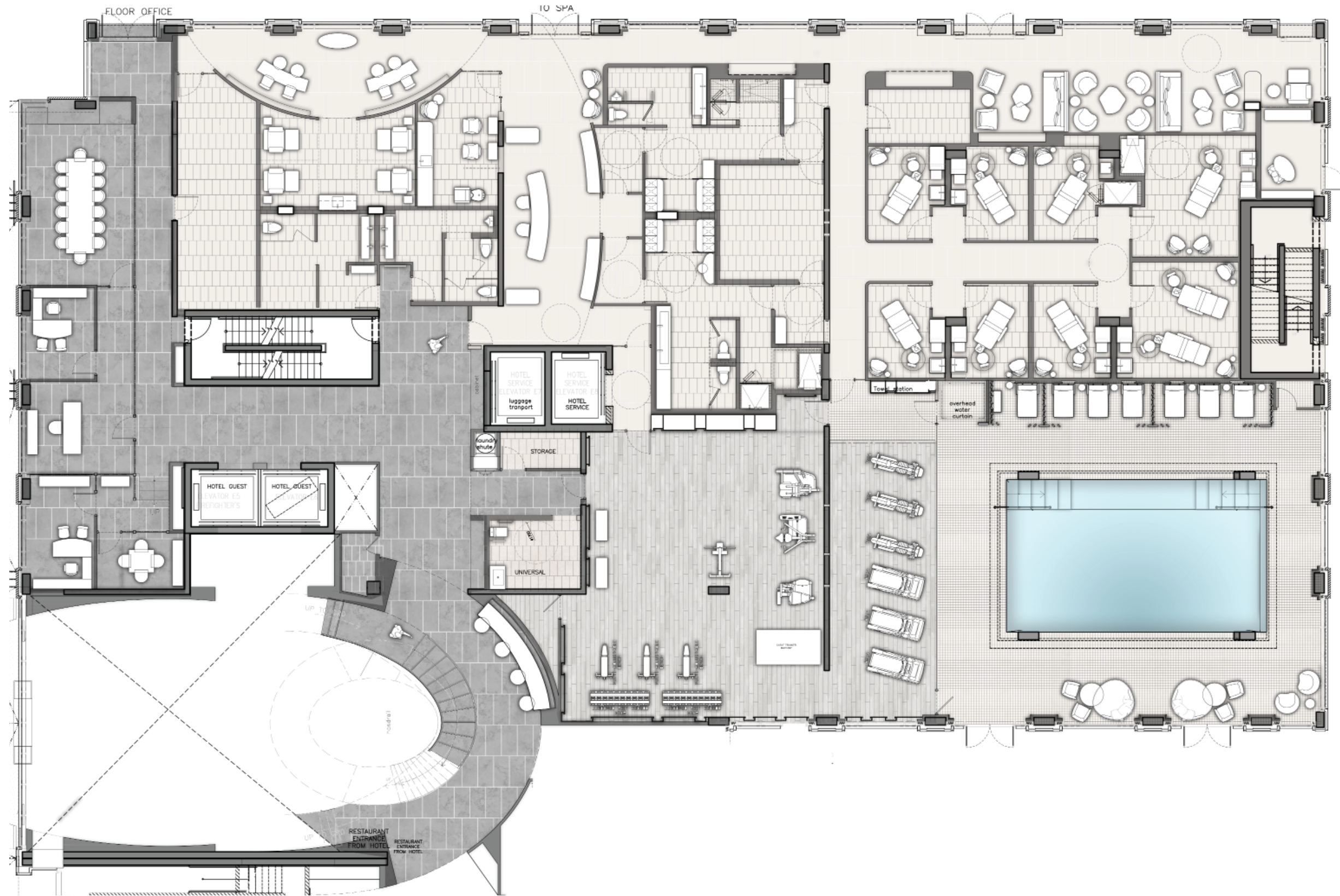

PUBLIC AREA UPPER GROUND FLOOR LOBBY REFLECTIVE CEILING PLAN

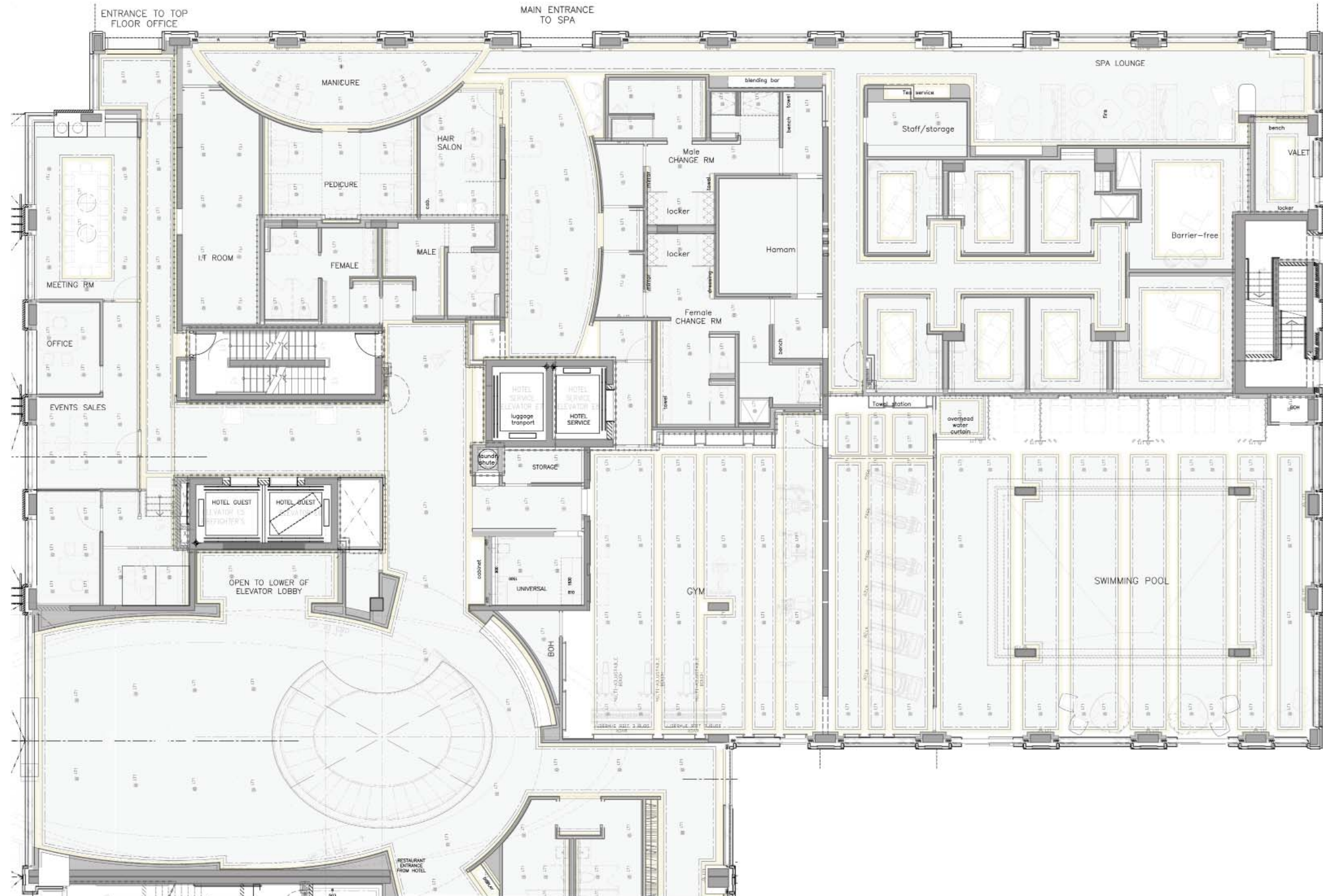

PUBLIC AREA UPPER GROUND FLOOR ELEVATOR LOBBY

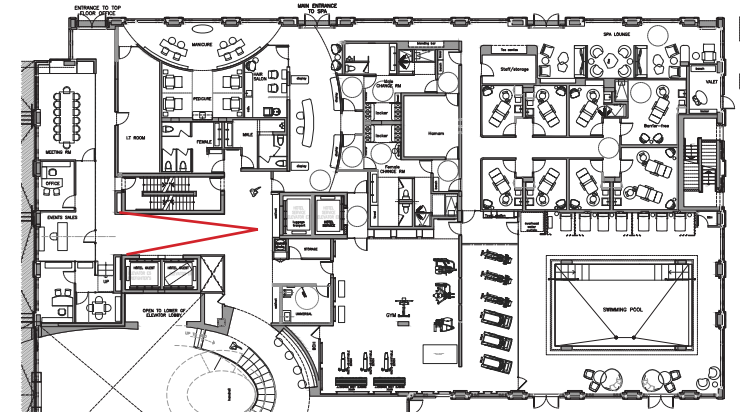

PUBLIC AREA UPPER GROUND FLOOR SPA RECEPTION AND RETAIL

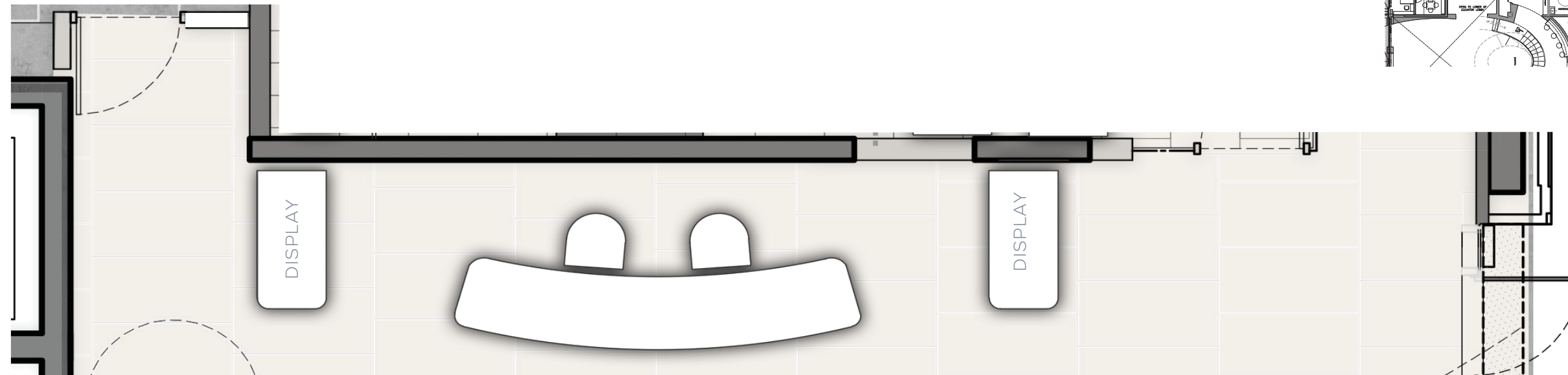
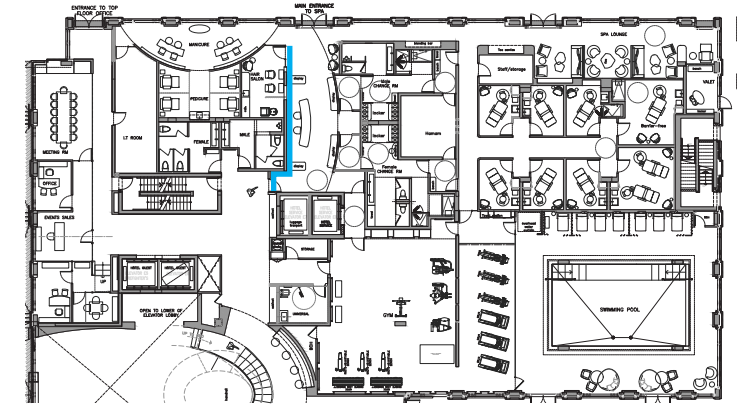

PLAN

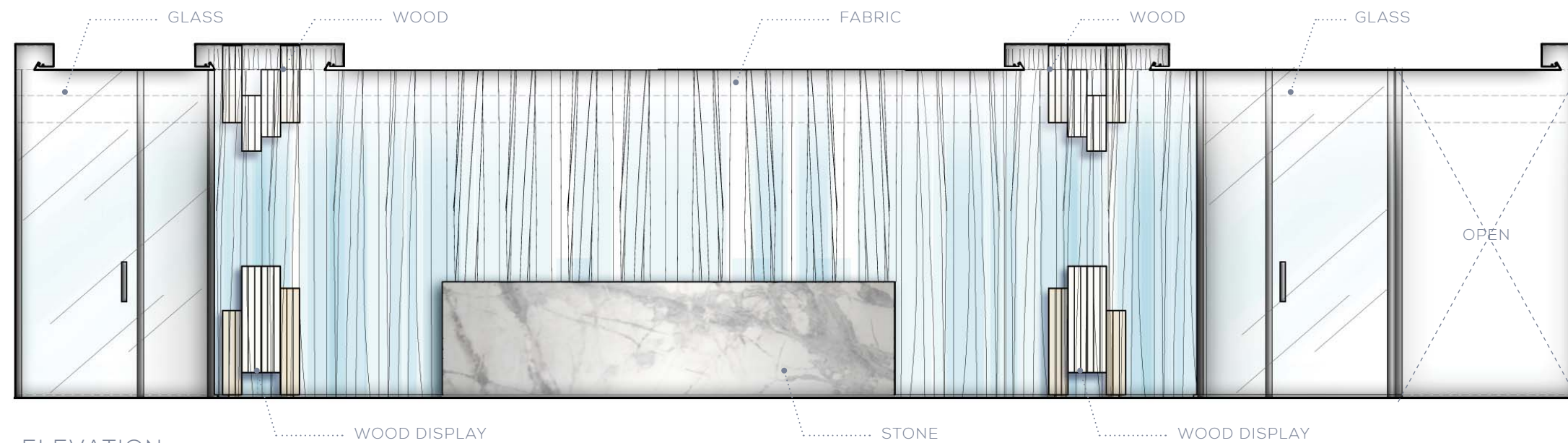

ELEVATION

PUBLIC AREA UPPER GROUND FLOOR SPA RECEPTION AND RETAIL

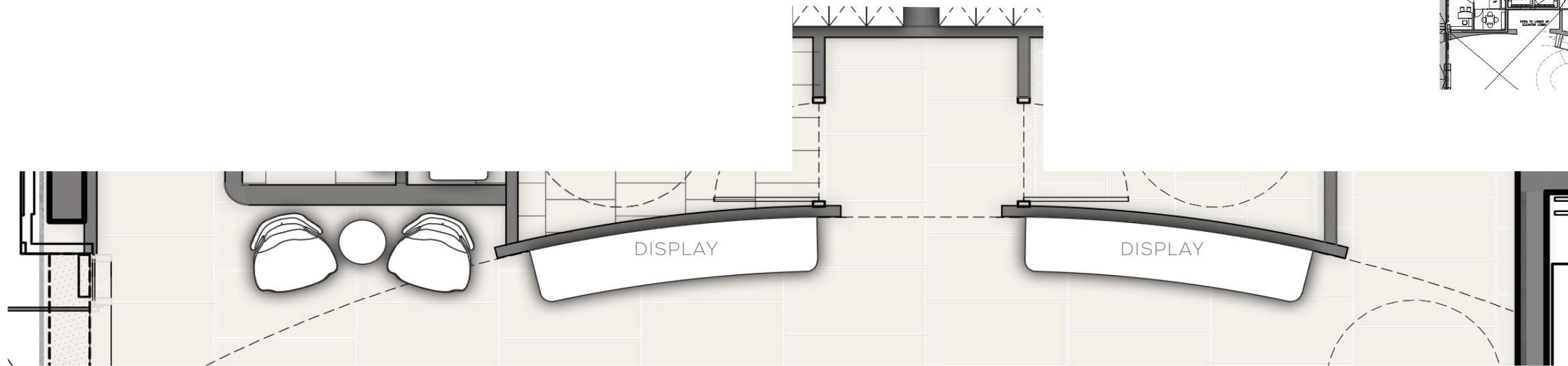
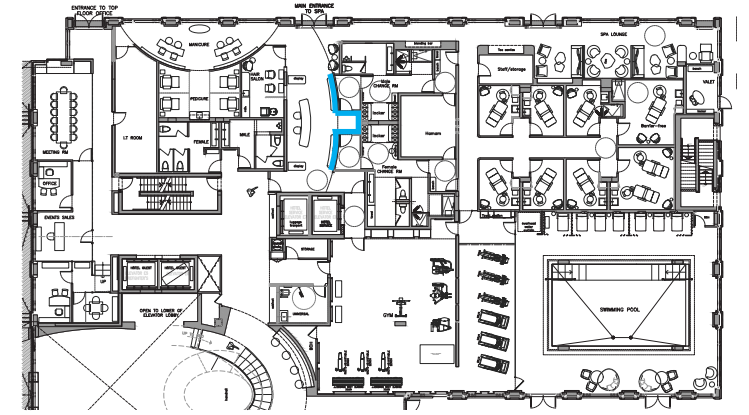

PLAN

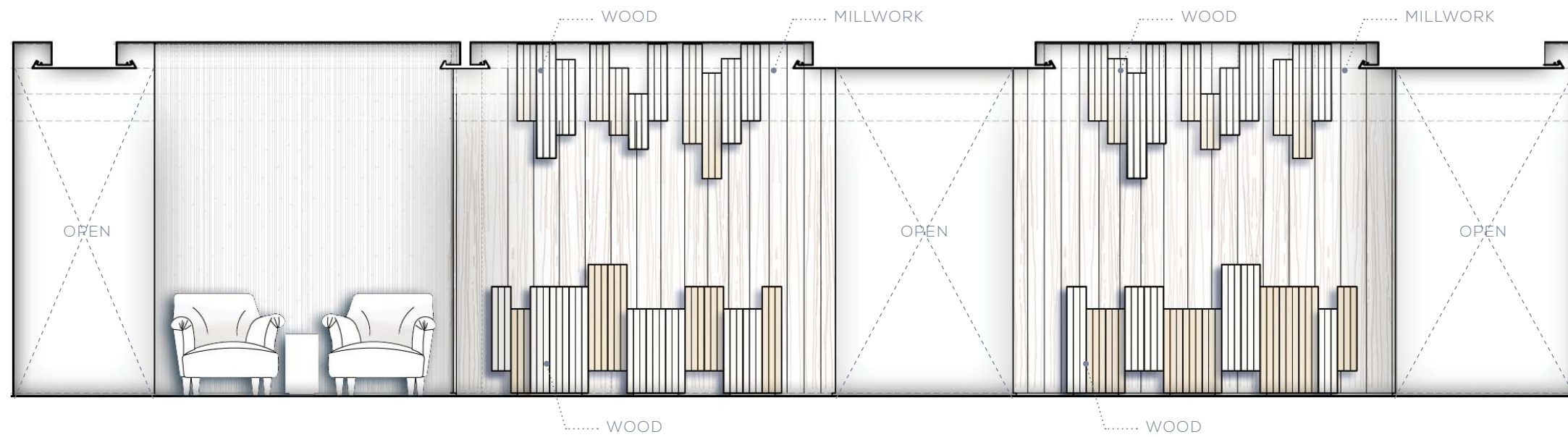

ELEVATION

PUBLIC AREA UPPER GROUND FLOOR SPA WAITING AREA AND BEVERAGE

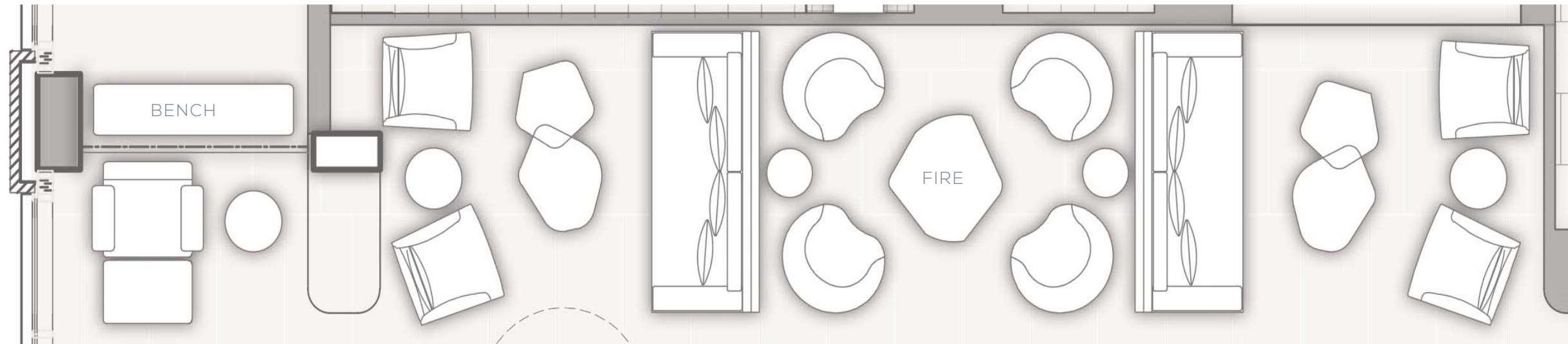
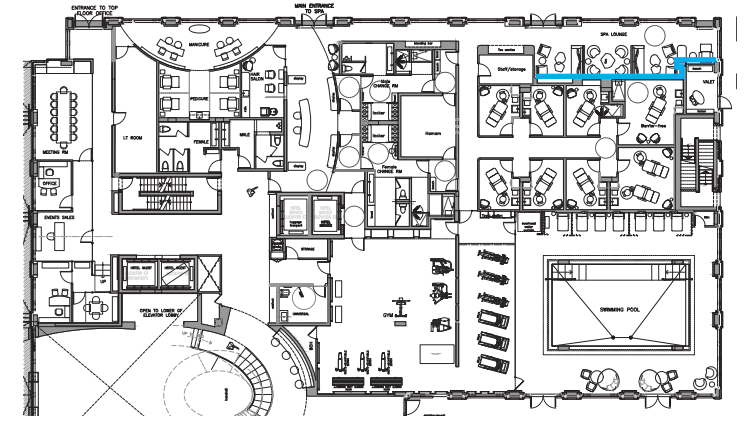

PLAN



ELEVATION

PUBLIC AREA UPPER GROUND FLOOR SPA MANICURE AND PEDICURE

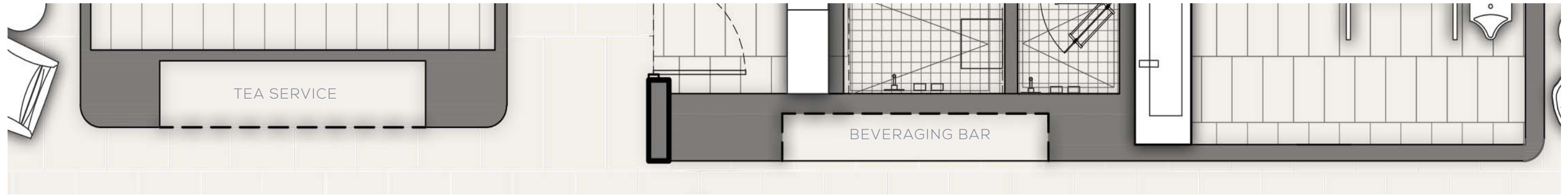
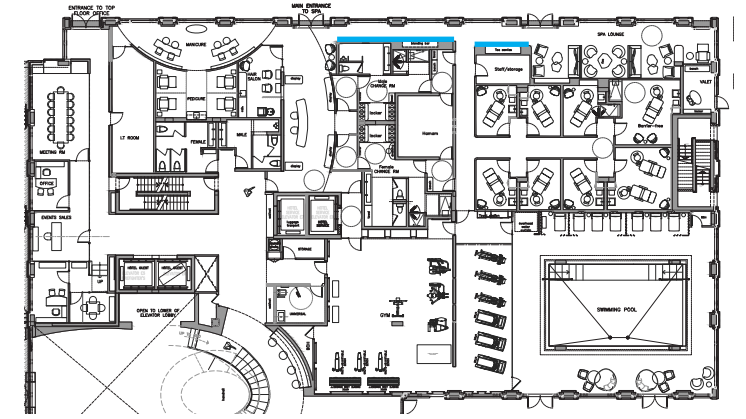

PLAN

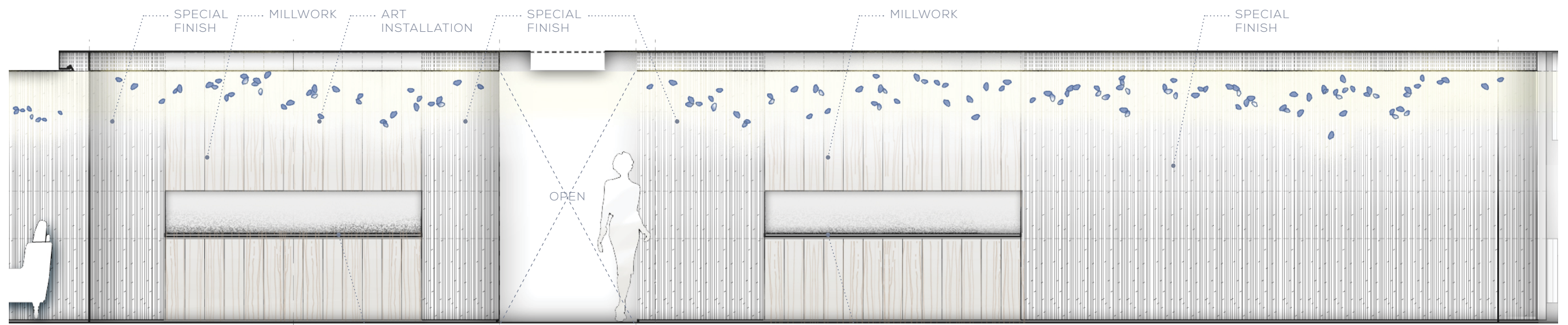

ELEVATION



PUBLIC AREA UPPER GROUND FLOOR SPA MANICURE AND PEDICURE

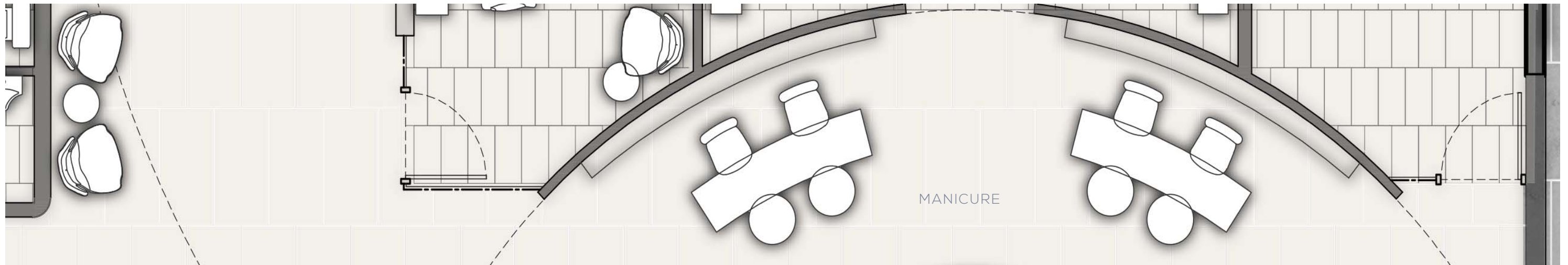
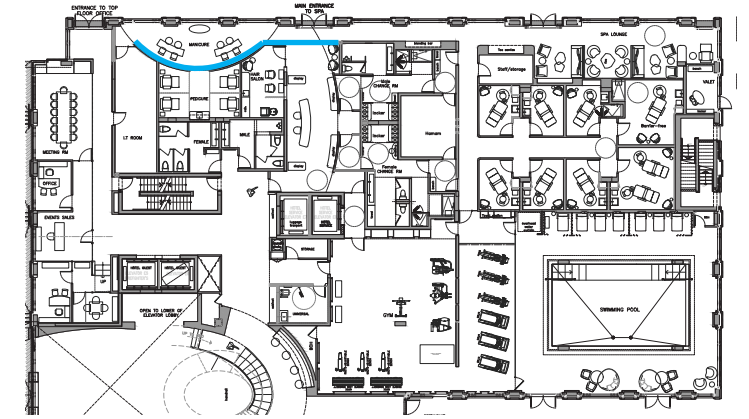

PLAN

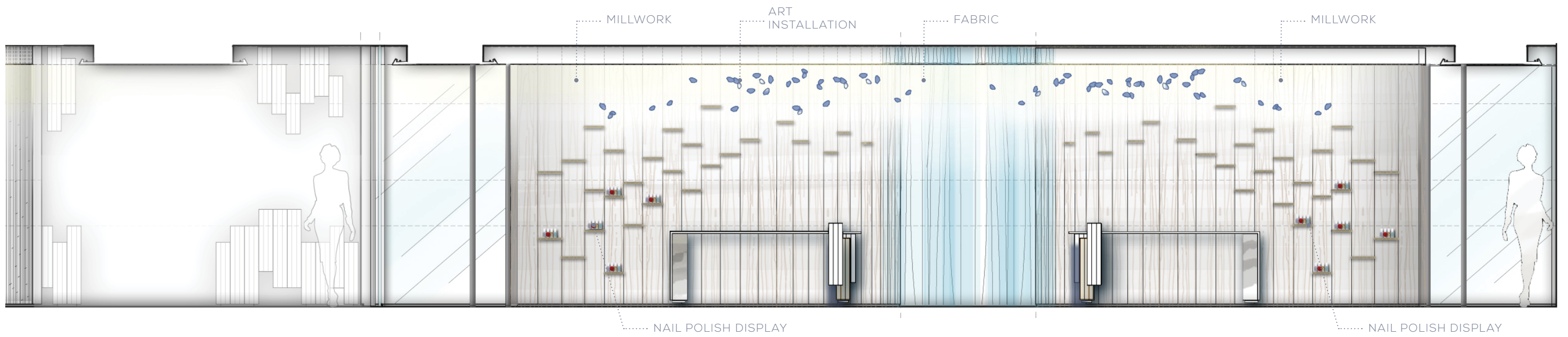

ELEVATION

PUBLIC AREA UPPER GROUND FLOOR SPA MANICURE AND PEDICURE

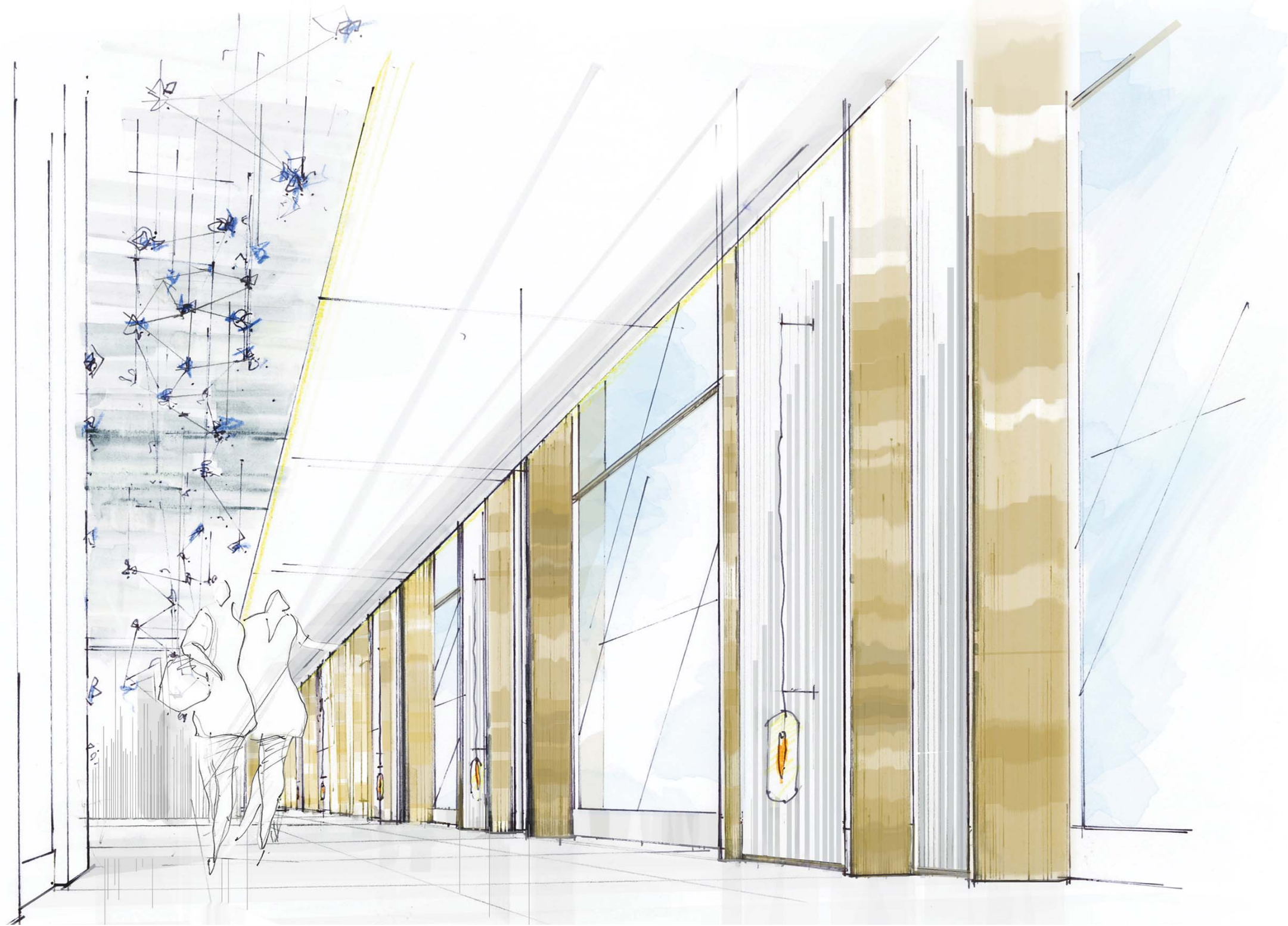
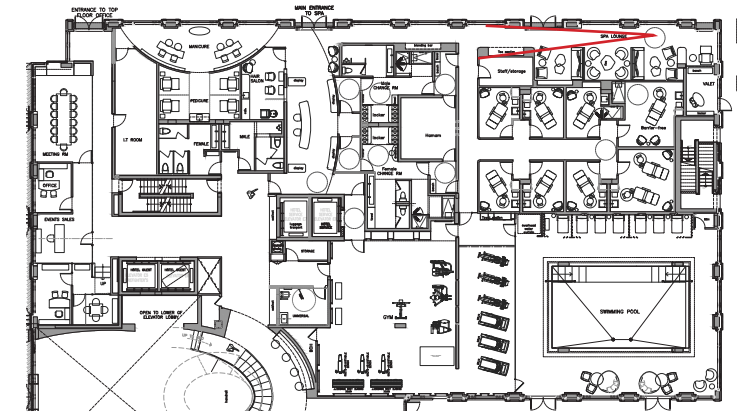

PUBLIC AREA UPPER GROUND FLOOR CHANGE ROOM

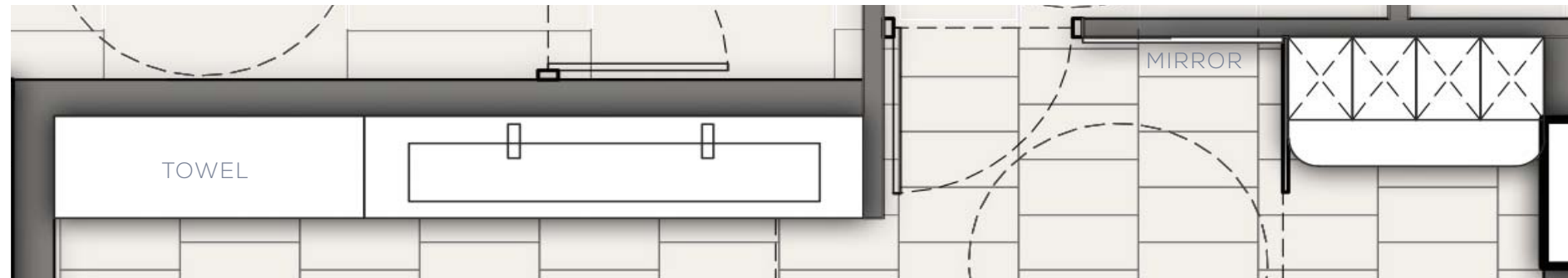
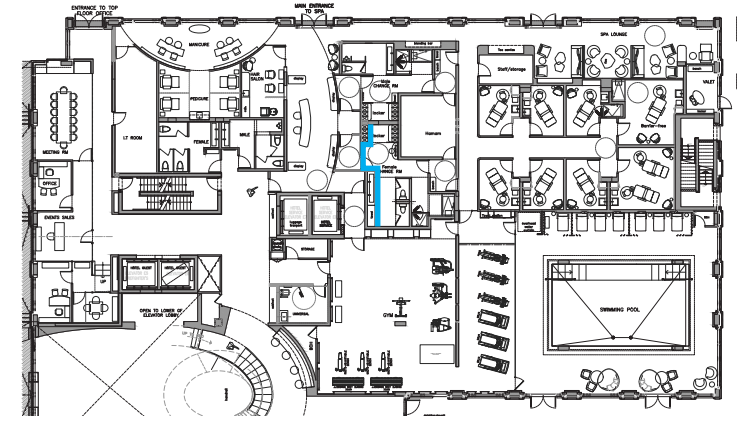

PLAN



ELEVATION

PUBLIC AREA UPPER GROUND FLOOR SPA TREATMENT ROOM

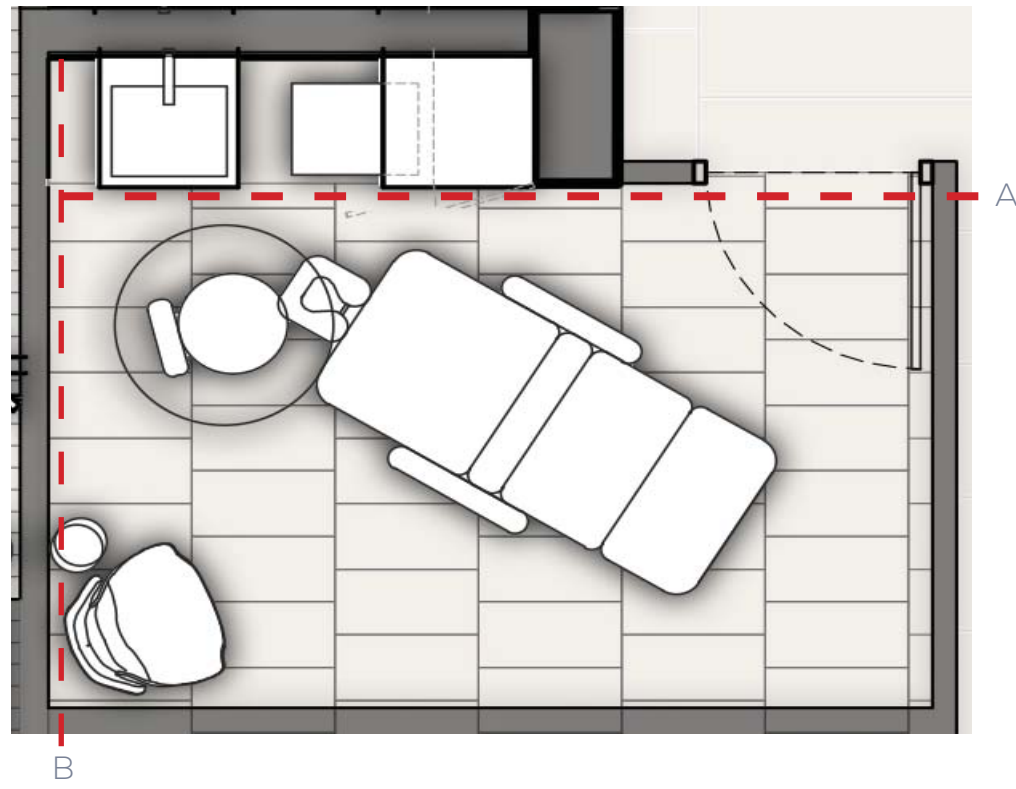
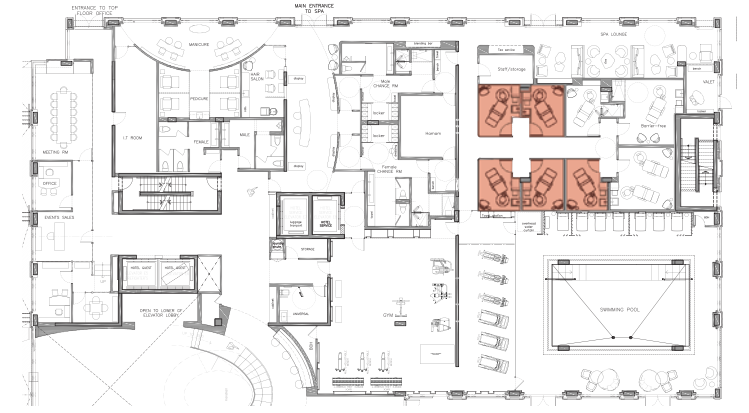

PLAN



ELEVATION: A

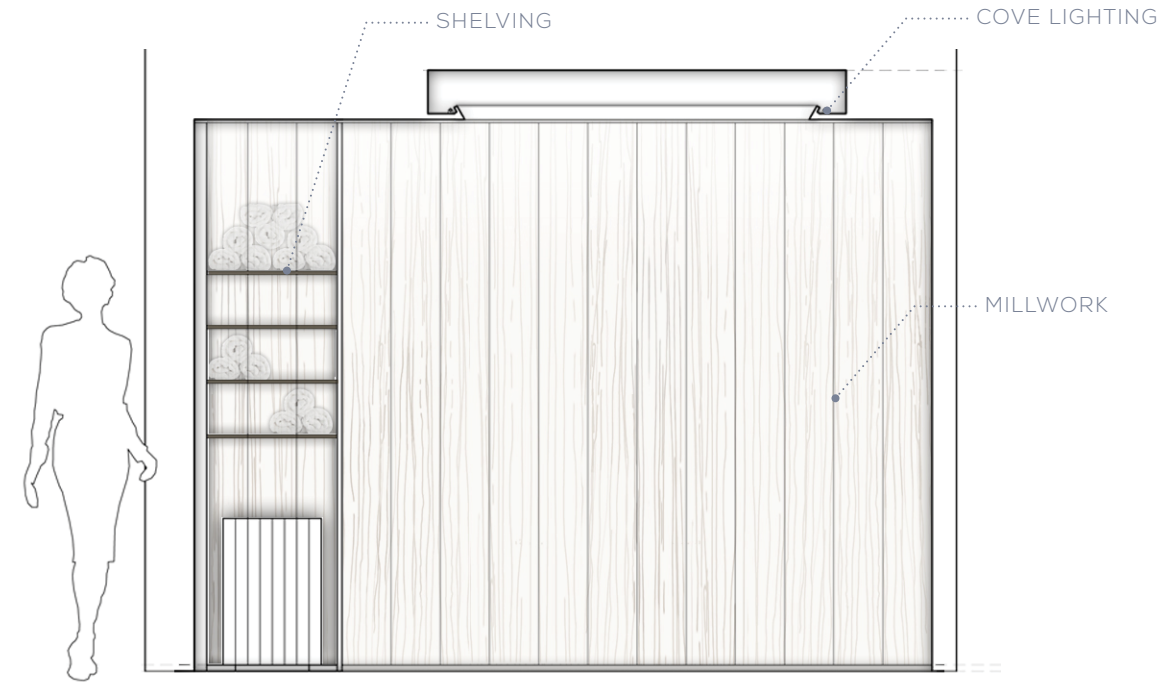

ELEVATION: B

PUBLIC AREA UPPER GROUND FLOOR SPA TREATMENT ROOM

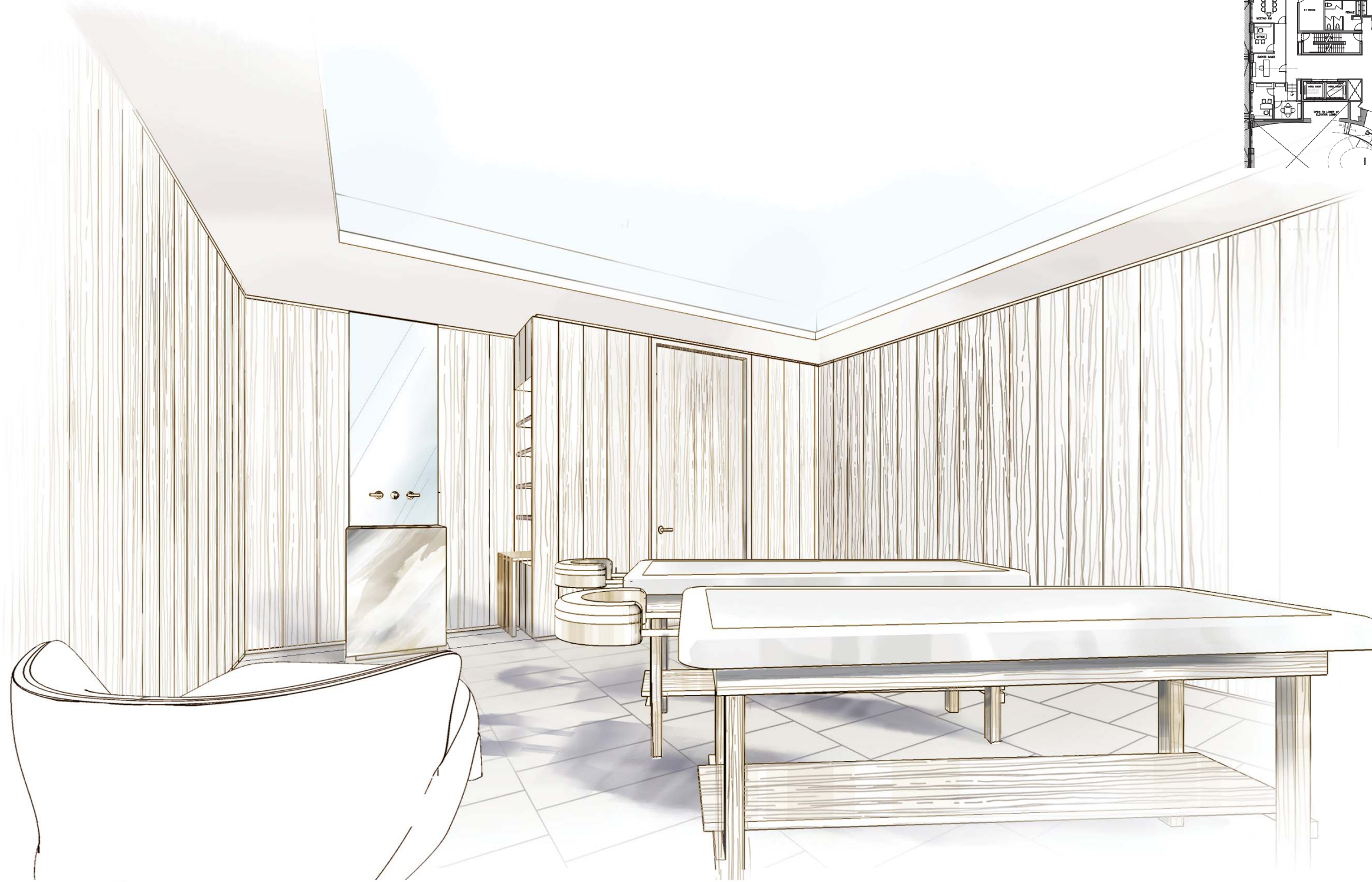
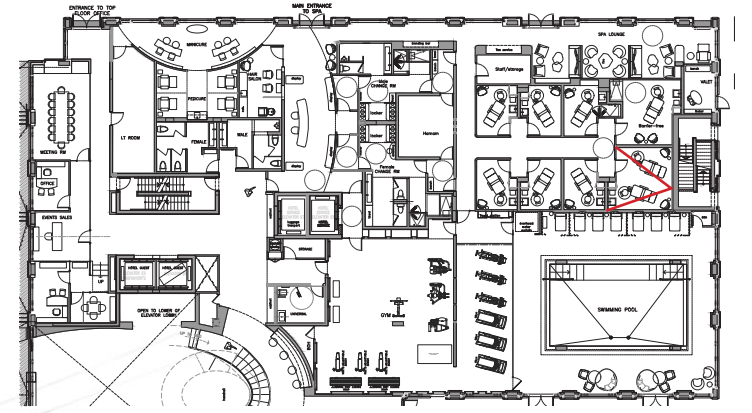

PUBLIC AREA UPPER GROUND FLOOR FITNESS



ELEVATION A

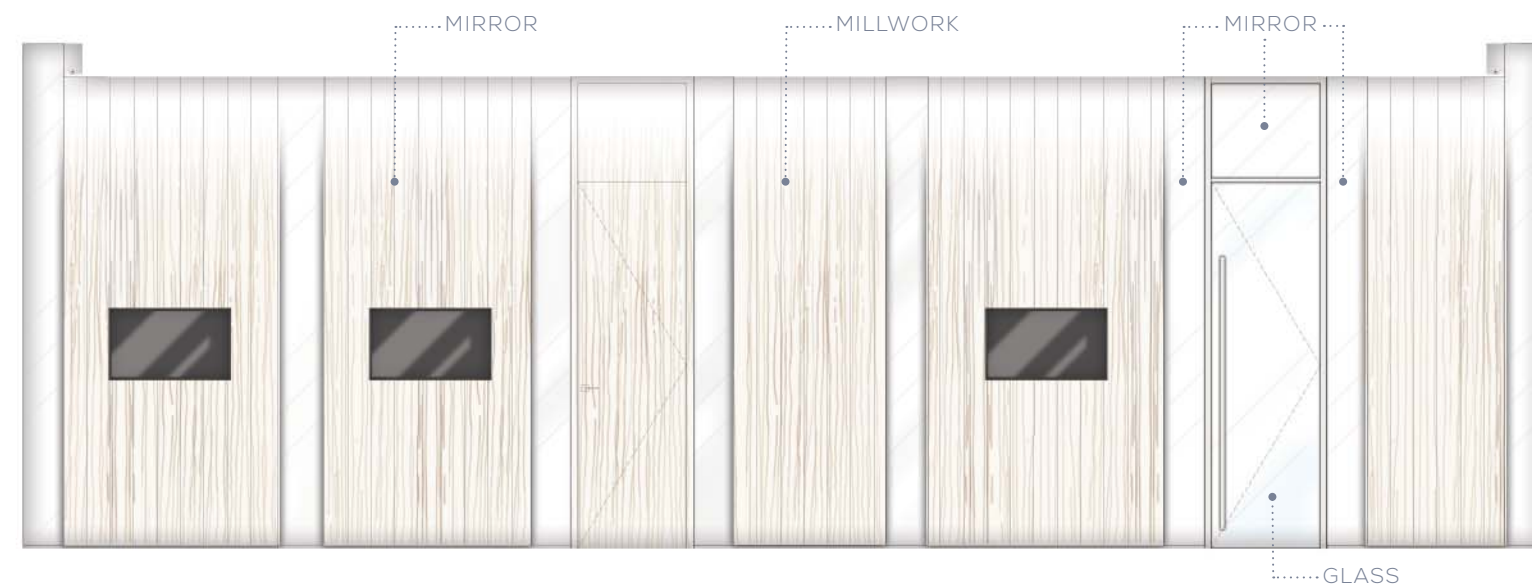

ELEVATION B

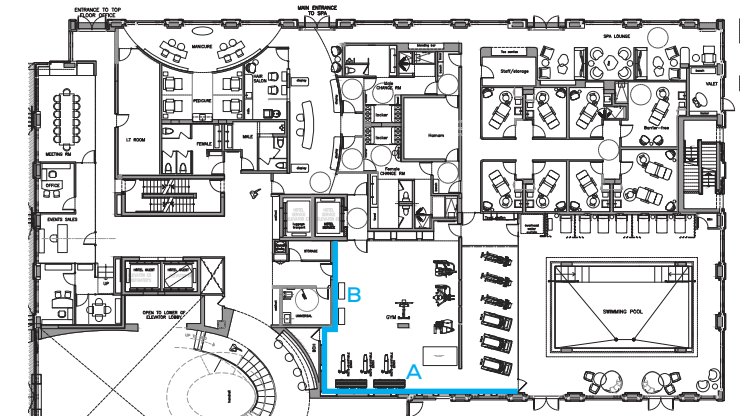

PUBLIC AREA UPPER GROUND FLOOR FITNESS



ELEVATION C



ELEVATION D

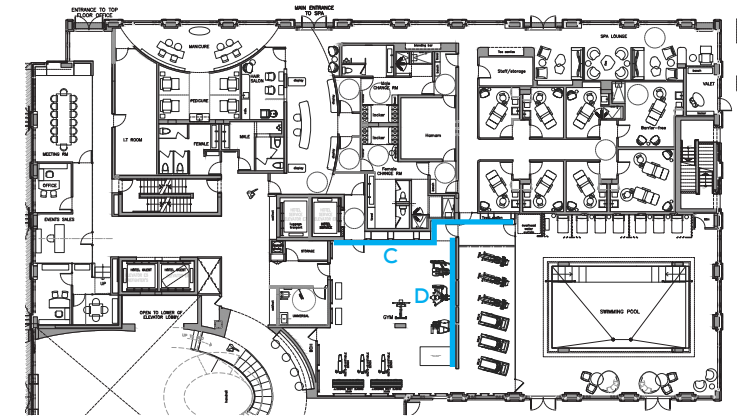

PUBLIC AREA UPPER GROUND FLOOR FITNESS



PUBLIC AREA UPPER GROUND FLOOR POOL

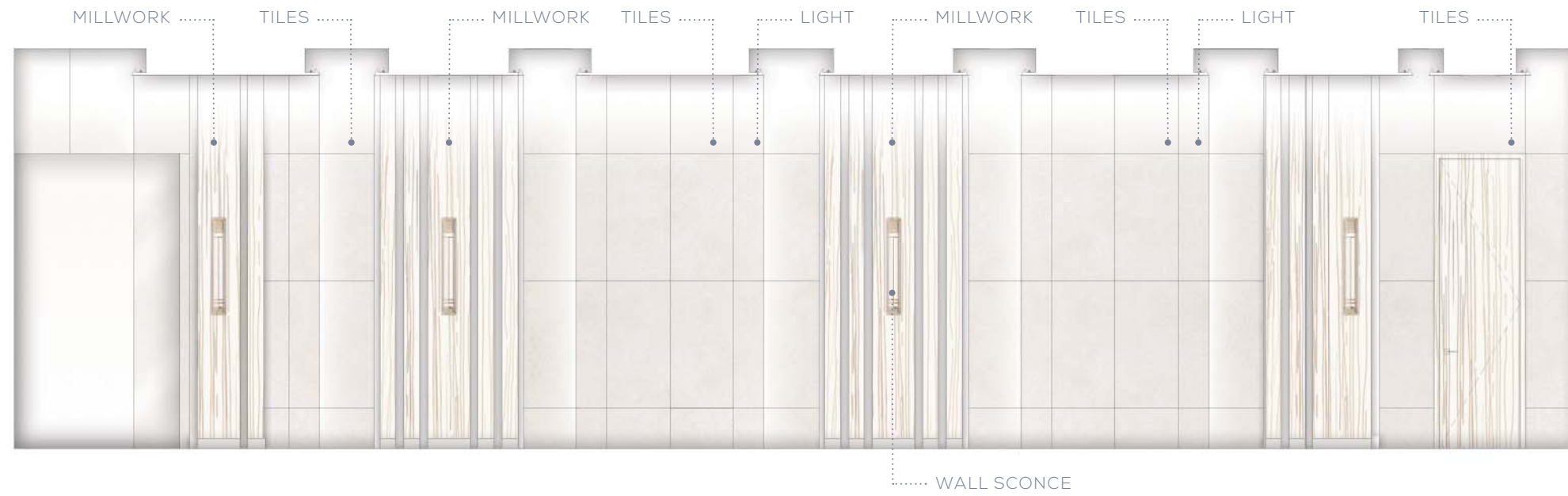

ELEVATION A



ELEVATION B

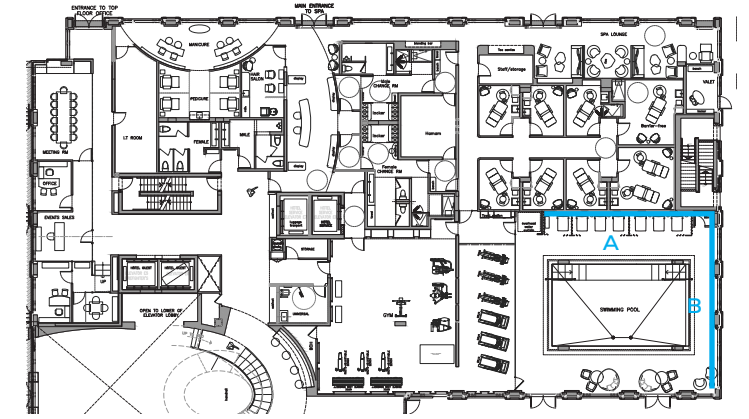

PUBLIC AREA UPPER GROUND FLOOR POOL



THANK YOU

